

OPERATING INSTRUCTIONS FOR

Model 2020

Thermal Conductivity Analyzer

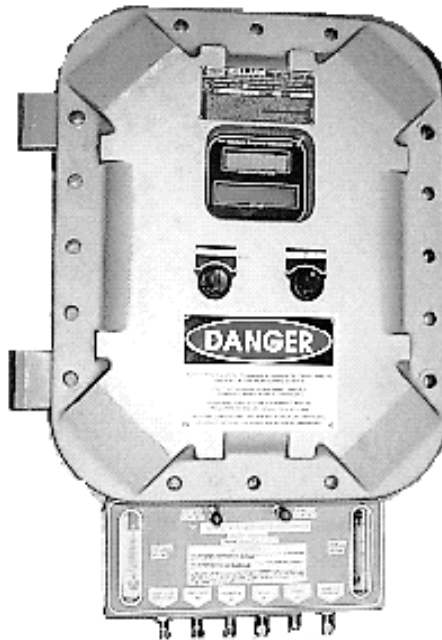

DANGER



HIGHLY TOXIC AND OR FLAMMABLE LIQUIDS OR GASES MAY BE PRESENT IN THIS MONITORING SYSTEM.

PERSONAL PROTECTIVE EQUIPMENT MAY BE REQUIRED WHEN SERVICING THIS SYSTEM.

HAZARDOUS VOLTAGES EXIST ON CERTAIN COMPONENTS INTERNALLY WHICH MAY PERSIST FOR A TIME EVEN AFTER THE POWER IS TURNED OFF AND DISCONNECTED.

ONLY AUTHORIZED PERSONNEL SHOULD CONDUCT MAINTENANCE AND/OR SERVICING. BEFORE CONDUCTING ANY MAINTENANCE OR SERVICING CONSULT WITH AUTHORIZED SUPERVISOR/MANAGER.

P/N M67677
08/06/1999
ECO # 99-0323

Copyright © 1999 Teledyne Analytical Instruments

All Rights Reserved. No part of this manual may be reproduced, transmitted, transcribed, stored in a retrieval system, or translated into any other language or computer language in whole or in part, in any form or by any means, whether it be electronic, mechanical, magnetic, optical, manual, or otherwise, without the prior written consent of Teledyne Analytical Instruments, 16830 Chestnut Street, City of Industry, CA 91749-1580.

Warranty

This equipment is sold subject to the mutual agreement that it is warranted by us free from defects of material and of construction, and that our liability shall be limited to replacing or repairing at our factory (without charge, except for transportation), or at customer plant at our option, any material or construction in which defects become apparent within one year from the date of shipment, except in cases where quotations or acknowledgments provide for a shorter period. Components manufactured by others bear the warranty of their manufacturer. This warranty does not cover defects caused by wear, accident, misuse, neglect or repairs other than those performed by Teledyne or an authorized service center. We assume no liability for direct or indirect damages of any kind and the purchaser by the acceptance of the equipment will assume all liability for any damage which may result from its use or misuse.

We reserve the right to employ any suitable material in the manufacture of our apparatus, and to make any alterations in the dimensions, shape or weight of any parts, in so far as such alterations do not adversely affect our warranty.

Important Notice

This instrument provides measurement readings to its user, and serves as a tool by which valuable data can be gathered. The information provided by the instrument may assist the user in eliminating potential hazards caused by his process; however, it is essential that all personnel involved in the use of the instrument or its interface, with the process being measured, be properly trained in the process itself, as well as all instrumentation related to it.

The safety of personnel is ultimately the responsibility of those who control process conditions. While this instrument may be able to provide early warning of imminent danger, it has no control over process conditions, and it can be misused. In particular, any alarm or control systems installed must be tested and understood, both as to how they operate and as to how they can be defeated. Any safeguards required such as locks, labels, or redundancy, must be provided by the user or specifically requested of Teledyne at the time the order is placed.

Therefore, the purchaser must be aware of the hazardous process conditions. The purchaser is responsible for the training of personnel, for providing hazard warning methods and instrumentation per the appropriate standards, and for ensuring that hazard warning devices and instrumentation are maintained and operated properly.

Teledyne Analytical Instruments, the manufacturer of this instrument, cannot accept responsibility for conditions beyond its knowledge and control. No statement expressed or implied by this document or any information disseminated by the manufacturer or its agents, is to be construed as a warranty of adequate safety control under the user's process conditions.

Specific Model Information

The instrument for which this manual was supplied may incorporate one or more options not supplied in the standard instrument. Commonly available options are listed below, with check boxes. Any that are incorporated in the instrument for which this manual is supplied are indicated by a check mark in the box.

Instrument Serial Number: _____

Standard Options Included in the Instrument with the Above Serial Number:

- 2020L:** Gas selector panel consisting of sample/ref flow meters with stainless steel control valves, tubing and fittings.
- 2020C:** Auto Calibration valves (zero/span) built-in gas selector panel and control valves are electronically controlled to provide synchronization with the analyzer's operations.
- 2020R:** Sealed reference TC cell (application dependent, contact factory).

Special Options:

- 2020F:** Groups C & D Flame Arrestors with Flow Control Gas Panel.
- 2020H:** Stainless Cell Block with Gold Filaments.
- 2020O:** Groups B Flame Arrestors with Flow Control Gas Panel.
- 2020P:** Groups C & D Flame Arrestors with Cal Valves and Flow Control Gas Panel.
- 2020Q:** Groups B Flame Arrestors with Cal Valves and Flow Control Gas Panel.

Table of Contents

1 Introduction

| | |
|--|-----|
| 1.1 Overview | 1-1 |
| 1.2 Typical Applications | 1-1 |
| 1.3 Main Features of the Analyzer | 1-2 |
| 1.4 Model Designations | 1-3 |
| 1.5 Operator Interface (Front Panel) | 1-3 |
| 1.5.1 UP/DOWN Switch | 1-4 |
| 1.5.2 ESCAPE/ENTER Switch | 1-5 |
| 1.6 Recognizing Difference Between LCD & VFD | 1-5 |
| 1.7 Equipment Interface (Rear Panel) | 1-5 |
| 1.8 Gas Connections | 1-6 |

2 Operational Theory

| | |
|---|-----|
| 2.1 Introduction | 2-1 |
| 2.2 Sensor Theory | 2-1 |
| 2.2.1 Sensor Configuration | 2-1 |
| 2.2.2 Calibration | 2-2 |
| 2.2.3 Effects of Flowrate and Gas Density | 2-3 |
| 2.2.4 Measurement Results | 2-3 |
| 2.3 Electronics and Signal Processing | 2-3 |
| 2.4 Temperature Control | 2-5 |

3 Installation

| | |
|---|------|
| 3.1 Unpacking the Analyzer | 3-1 |
| 3.2 Mounting the Analyzer | 3-1 |
| 3.3 Electrical Connections (Rear Panel) | 3-3 |
| 3.3.1 Primary Input Power | 3-3 |
| 3.3.2 Fuse Installation | 3-4 |
| 3.3.3 Voltage Selections | 3-4 |
| 3.3.4 Analog Outputs | 3-4 |
| 3.3.5 Alarm Relays | 3-6 |
| 3.3.6 Digital Remote Cal Inputs | 3-7 |
| 3.3.7 Range ID Relays | 3-8 |
| 3.3.8 Network I/O | 3-9 |
| 3.3.9 RS-232 Port | 3-9 |
| 3.3.10 Remote Probe Connector | 3-10 |
| 3.4 Gas Connections | 3-11 |
| 3.4.1 Sample System Design | 3-13 |
| 3.4.2 Pressure and Flow Rate Regulation | 3-14 |

| | | |
|-------|--------------------------|------|
| 3.4.3 | VENT Exhaust | 3-14 |
| 3.4.4 | SAMPLE Gas | 3-15 |
| 3.4.5 | REFERENCE Gas | 3-15 |
| 3.4.6 | ZERO Gas | 3-16 |
| 3.4.7 | SPAN Gas | 3-16 |
| 3.5 | Testing the System | 3-16 |

4 Operation

| | | |
|---------|---|------|
| 4.1 | Introduction | 4-1 |
| 4.2 | Using the Data Entry and Function Buttons | 4-2 |
| 4.2.1 | Mode/Function Selection | 4-2 |
| 4.2.1.1 | Analysis Mode | 4-2 |
| 4.2.1.2 | Setup Mode | 4-4 |
| 4.2.2 | Data Entry | 4-5 |
| 4.2.2.1 | ENTER | 4-5 |
| 4.2.2.2 | Escape | 4-5 |
| 4.3 | The <i>System</i> Function | 4-6 |
| 4.3.1 | Setting the Display | 4-6 |
| 4.3.2 | Setting up an Auto-Cal | 4-6 |
| 4.3.3 | Password Protection | 4-7 |
| 4.3.3.1 | Entering the Password | 4-7 |
| 4.3.3.2 | Installing or Changing the Password | 4-8 |
| 4.3.4 | Logging Out | 4-10 |
| 4.3.5 | System Self-Diagnostic Test | 4-10 |
| 4.3.6 | The Model Screen | 4-11 |
| 4.3.7 | Checking Linearity with Algorithm | 4-11 |
| 4.4 | The <i>Zero</i> and <i>Span</i> Functions | 4-12 |
| 4.4.1 | Zero Cal | 4-13 |
| 4.4.1.1 | Auto Mode Zeroing | 4-13 |
| 4.4.1.2 | Manual Mode Zeroing | 4-14 |
| 4.4.1.3 | Cell Failure | 4-15 |
| 4.4.2 | Span Cal | 4-16 |
| 4.4.2.1 | Auto Mode Spanning | 4-16 |
| 4.4.2.2 | Manual Mode Spanning | 4-17 |
| 4.5 | The <i>Alarms</i> Function | 4-17 |
| 4.6 | The <i>Range</i> Select Function | 4-19 |
| 4.6.1 | Manual (Select/Define Range) Screen | 4-20 |
| 4.6.2 | Auto (Single Application) Screen | 4-20 |
| 4.6.3 | Precautions | 4-22 |
| 4.7 | The <i>Analyze</i> Function | 4-22 |
| 4.8 | Programming | 4-23 |

| | | |
|---------|----------------------------------|------|
| 4.8.1 | The Set Application Screen | 4-24 |
| 4.8.2 | The Curve Algorithm Screen | 4-26 |
| 4.8.2.1 | Checking the Linearization | 4-26 |
| 4.8.2.2 | Manual Mode Linearization | 4-27 |
| 4.8.2.3 | Auto Mode Linearization | 4-28 |
| 4.9 | Special Function Setup | 4-29 |
| 4.9.1 | Output Signal Reversal | 4-29 |
| 4.9.1.1 | Output Signal Reversal | 4-29 |
| 4.9.1.2 | Output Signal Offset | 4-30 |
| 4.9.2 | Polarity Reversal | 4-30 |
| 4.9.3 | Gain Preset | 4-31 |

Maintenance

| | | |
|-------|--|-----|
| 5.1 | Routine Maintenance | 5-1 |
| 5.2 | System Self Diagnostic Test | 5-1 |
| 5.3 | Fuse Replacement | 5-2 |
| 5.4 | Major Internal Components | 5-3 |
| 5.5 | Voltage Selections | 5-3 |
| 5.6 | Cell, Heater, or Thermistor Replacement | 5-5 |
| 5.6.1 | Removing the Cell Compartment | 5-5 |
| 5.6.2 | Removing and Replacing the Cell Block | 5-6 |
| 5.6.3 | Removing the Heater and/or Thermocouple | 5-7 |
| 5.6.4 | Replacing the Heater and/or Thermocouple | 5-8 |
| 5.7 | Cleaning | 5-9 |
| 5.8 | Phone Numbers | 5-9 |

Appendix

| | | |
|-----|---|-----|
| A-1 | Specifications | A-1 |
| A-2 | Recommended 2-Year Spare Parts List | A-3 |
| A-3 | Drawing List | A-4 |

Introduction

1.1 Overview

The Analytical Instruments Model 2020 Thermal Conductivity Analyzer, explosion proof, UL and CSA listed for class 1, DIV 1, Groups B, C, and D service, is a versatile microprocessor-based instrument for measuring a component gas in a background gas, or in a specific mixture of background gases. It compares the thermal conductivity of a sample stream with that of a reference gas of known composition. The 2020 can—

- measure the concentration of one gas in a mixture of two gases.
- measure the concentration of a gas in a specific mixture of background gases.
- measure the purity of a sample stream containing a single impurity or a mixture of impurities.

The standard 2020 is preprogrammed with automatic linearization algorithms for a large number of gases and gas mixtures. The factory can add to this data base for custom applications, and the sophisticated user can add his own unique applications.

Many of the Model 2020 features covered in this manual are optional, selected according to the customer's specific application. Therefore, the user may find much here that does not apply to his instrument. This is unavoidable due to the number of possible combinations of features available. We have endeavored to make the manual as usable and convenient as possible, in light of this flexibility.

1.2 Typical Applications

A few typical applications of the Model 2020 are:

- Power Generation
- Air liquefaction
- Chemical reaction monitoring
- Steel manufacturing and heat treating
- Petrochemical process control
- Quality assurance
- Refrigeration and storage
- Gas proportioning control.

1.3 Main Features of the Analyzer

The main features of the Model 2020 Thermal Conductivity Analyzer include:

- Three independent, user definable, analysis ranges allow up to three different gas applications with one concentration range each, or up to three concentration ranges for a single gas application, or any combination.
- Special recalibration range for multiple applications. Recalibrating one, recalibrates all.
- Automatic, independent linearization for each range.
- Auto Ranging allows analyzer to automatically select the proper preset range for a given single application. Manual override allows the user to lock onto a specific range of interest.
- RS-232 serial digital port for use with a computer or other digital communications device.
- Six adjustable set points concentration with two alarms and a system failure alarm relays.
- Extensive self-diagnostic testing, at startup and on demand.
- Sample and Hold for holding analyzer's output during Auto calibration mode.
- A 2-line alphanumeric display screen, driven by microprocessor electronics, that continuously prompts and informs the operator.

- High resolution, accurate indication of target or impurity gas concentration from large, bright, meter readout. (0-9999 ppm through 0-100 % depending on types of gas involved.)
- Standard, proven sensor cell design.
- Wide range of custom applications, ranges, and linearization.
- Microprocessor based electronics: 8-bit CMOS microprocessor with 32 kB RAM and 128 kB ROM.
- Auto and remote calibration capabilities.
- Four analog outputs: two for measurement (0–1 V dc and Isolated 4–20 mA dc) and two for range identification.
- Compact and versatile design: Small footprint, yet internal components are accessible.

1.4 Model Designations

The Model 2020 is ordinarily custom programmed at the factory to fit the customer's application. Many parameters, including the number of channels, the gas application, the materials specification of the sampling system, and others, are options. The most common options, are covered in this manual. See the *Specific Model Information* checklist in the front matter of this manual for those that apply to your Model 2020 analyzer. Some standard models that are not covered in this manual are listed here.

Models 2000B: NEMA-4, bulkhead mounted enclosure for general purpose, nonhazardous environments.

Models 2010: Split architecture models using a sealed explosion-proof enclosure for the Analysis Unit and a general purpose remote Control Unit for installation in a safe area.

Models 2020: Both the analysis section and control unit are in a single explosion proof enclosure.

1.5 Operator Interface (Front Panel)

The Model 2020 is housed in a explosion proof housing. See Figure 1-1. The front panel has two single operator controls, a digital meter, and an alphanumeric display. They are described briefly here and in detail in the *Operations* chapter of this manual.

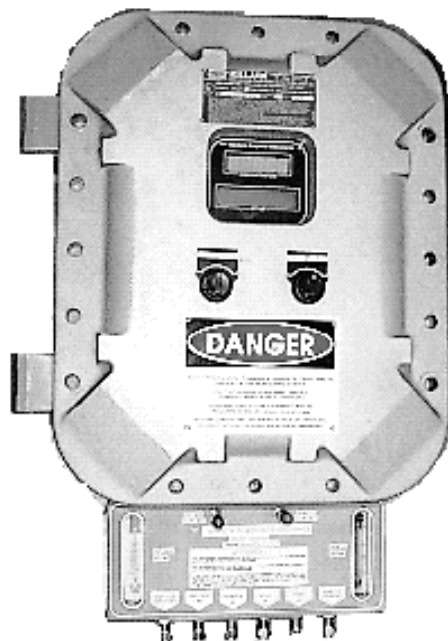

Figure 1-1: Model 2020 Front Panel

1.5.1 UP/DOWN Switch

Functions: The UP/DOWN switch is used to select the function to be performed. Choose UP or DOWN to scroll through the following list of fourteen functions:

- **AUTO-CAL** Set up an automatic calibration sequence.
- **PSWD** Install a password to protect your analyzer setup.
- **LOGOUT** Locks Setup Mode.
- **MODEL** Displays model and version of analyzer.
- **SELF-TEST** Runs internal diagnostic program, displays results.
- **SPAN** Span calibrate the analyzer.
- **ZERO** Zero calibrate the analyzer.
- **ALARMS** Set the alarm setpoints and attributes.
- **RANGE** Set up the 3 user definable ranges for the instrument.
- **APPLICATION** Set up the 3 definable application ranges
- **ALGORITHM** Set up the linearization
- **CAL-INDEPD** Calibration range independently

- **CONTRAST** Adjust LCD contrast. **Contrast Function is *DISABLED*** (Refer to Section 1.6)
- **STANDBY** Leave analyzer powered, but no outputs or displays.



WARNING: THE POWER CABLE MUST BE DISCONNECTED TO FULLY REMOVE POWER FROM THE INSTRUMENT.

Subfunctions: Once a Function is entered, the UP/DOWN switch is used to select between any subfunctions displayed on the VFD screen.

Parameter values: When modifiable values are displayed on the VFD, the UP/DOWN switch can be used to increment or decrement the values.

1.5.2 ESCAPE/ENTER Switch

Data Entry: The ESCAPE/ENTER switch is used to input data, from the alphanumeric VFD screen into the instrument:

- **Escape** Moves VFD display back to the previous screen in a series. If none remains, returns to the *Analyze* screen.

With subfunction selected, moves VFD back through items on screen, to first item, then moves VFD to previous display.

- **Enter** With a Subfunction Selected: Moves VFD on to the next screen in a series. If none remains, returns to the *Analyze* screen.

With a Value Selected: Enters the value into the analyzer as data. Advances VFD to next operation.

(See Chapter 4 for details.)

1.6 Recognizing Difference Between LCD & VFD

LCD has *GREEN* background with *BLACK* characters. VFD has *DARK* background with *GREEN* characters. In the case of VFD - *NO CONTRAST ADJUSTMENT IS NEEDED*.

1.7 Equipment Interface

The electrical connection are described briefly here and in detail in chapter 3, *Installation*.

Electrical Connections: The electrical connections on the electrical connector panel are described briefly here, and in more detail in chapter 3 *Installation*.

-
- **Power Connection** 115 or 230 V dc, 50 or 60 Hz.
 - **Analog Outputs** 0-1 V dc concentration plus 0-1 V dc range ID. Additional, isolated 4-20 mA dc plus 4-20 mA dc range ID available.
 - **Alarm Connections** 2 concentration alarms and 1 system alarm.
 - **RS-232 Port** Serial digital concentration signal output and control input.
 - **Remote Valves** Used for controlling external solenoid valves, if desired.
 - **Remote Sensor** Used for external sensor and thermocouple, if desired.
 - **Remote Span/Zero** Digital inputs allow external control of analyzer calibration.
 - **Calibration Contact** To notify external equipment that instrument is being calibrated and readings are not monitoring sample.
 - **Range ID Contacts** Four separate, dedicated, range relay contacts. Low, Medium, High, Cal.
 - **Network I/O** Serial digital communications for local network access. For future expansion. Not implemented at this printing.

1.8 Gas Connections

The gas connectors are on the bottom of the Model 2020 chassis near the front door.

A sample system must be provided for introduction of zero and span gas, as well as sample gas, into the sample path, and for controlling the flowrates through the sample and reference paths of the analyzer. Appropriate pressure reducing regulators must be installed at all gas supply sources.

Gas Connector-and-Selector Panels for specific applications are available at additional cost. These panels are optional designed to substitute a standard front panel.

For those customers wishing to incorporate their own sample controls, the recommended system piping schematic is included among the drawings at the rear of the manual.

Operational Theory

2.1 Introduction

The analyzer is composed of two subsystems:

1. Thermal Conductivity Sensor
2. Electronic Signal Processing, Display and Control.

The sensor is a thermal conductivity comparator that continuously compares the thermal conductivity of the sample gas with that of a reference gas having a known conductivity.

The electronic signal processing, display and control subsystem simplifies operation of the analyzer and accurately processes the sampled data. A microprocessor controls all signal processing, input/output, and display functions for the analyzer.

2.2 Sensor Theory

For greater clarity, Figure 2-1 presents two different illustrations, (a) and (b), of the operating principle of the thermal conductivity cell.

2.2.1 Sensor Configuration

The thermal conductivity sensor contains two chambers, one for the reference gas of known conductivity and one for the sample gas. Each chamber contains a pair of heated filaments. Depending on its thermal conductivity, each of the gases conducts a quantity of heat away from the filaments in its chamber. See Figure 2-1(a).

The resistance of the filaments depends on their temperature. These filaments are parts of the two legs of a Wheatstone bridge circuit that unbalances if the resistances of its two legs do not match. See Figure 2-1(b).

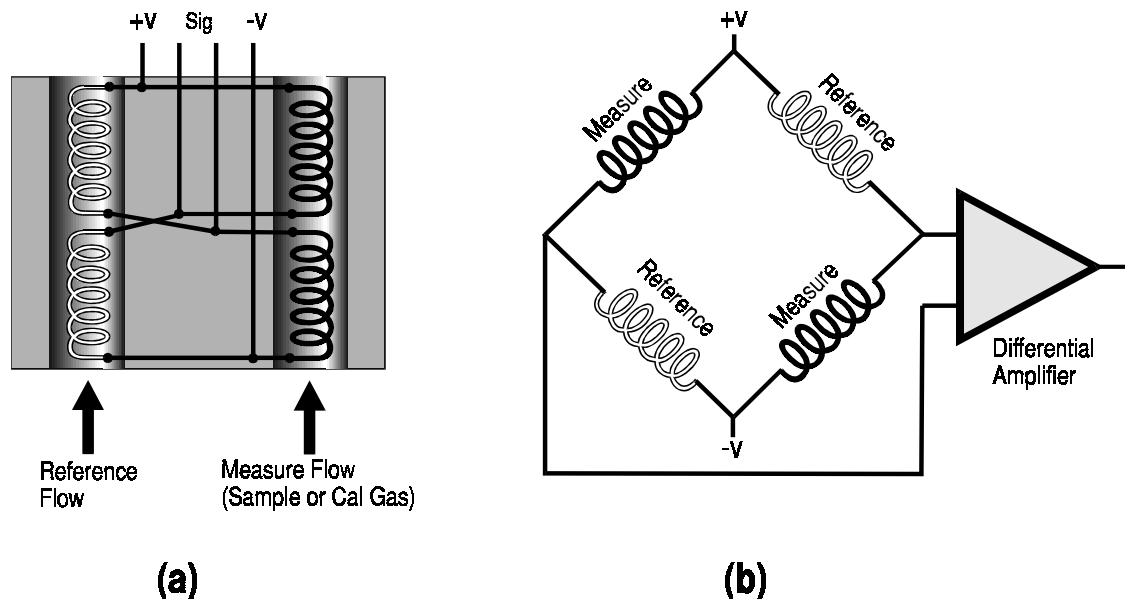

Figure 2-1: Thermal Conductivity Cell Operating Principle

If the thermal conductivities of the gases in the two chambers are different, the Wheatstone bridge circuit unbalances, causing a current to flow in its detector circuit. The amount of this current can be an indication of the amount of impurity in the sample gas, or even an indication of the type of gas, depending on the known properties of the reference and sample gases.

The temperature of the measuring cell is regulated to within 0.1 °C by a sophisticated control circuit. Temperature control is precise enough to compensate for diurnal effects in the output over the operating ranges of the analyzer. (See *Specifications* in the Appendix for details.)

2.2.2 Calibration

Because analysis by thermal conductivity is not an absolute measurement, calibration gases of **known composition** are required to fix the upper and lower parameters (“zero” and “span”) of the range, or ranges, of analysis. These gases must be used periodically, to check the **accuracy of the analyzer**.

During calibration, the bridge circuit is balanced, with zero gas against the reference gas, at one end of the measurement range; and it is sensitized with span gas against the reference gas at the other end of the measurement range. The resulting electrical signals are processed by the analyzer electronics to produce a standard 0-1V, or an isolated 4–20 mA dc, output signal, as described in the next section.

2.2.3 Effects of Flowrate and Gas Density

Because the flowrate of the gases in the chambers affects their cooling of the heated filaments, the flowrate in the chambers must be kept as equal, constant, and low as possible.

When setting the sample and reference flowrate, note that gases lighter than air will have an actual flowrate higher than indicated on the flowmeter, while gases heavier than air will have an actual flowrate lower than indicated. Due to the wide range of gases that are measured with the Thermal Conductivity Analyzer, the densities of the gases being handled may vary considerably.

Then, there are limited applications where the reference gas is in a sealed chamber and does not flow at all. These effects must be taken in consideration by the user when setting up an analysis.

2.2.4 Measurement Results

Thermal conductivity measurements are nonspecific by nature. This fact imposes certain limitations and requirements. If the user intends to employ the analyzer to detect a specific component in a sample stream, the sample must be composed of the component of interest and one other gas (or specific, and constant, mixture of gases) in order for the measured heat-transfer differences to be nonambiguous.

If, on the other hand, the user is primarily interested in the purity of a process stream, and does not require specific identification of the impurity, the analyzer can be used on more complex mixtures.

2.3 Electronics and Signal Processing

The Model 2020 Thermal Conductivity Analyzer uses an 8031 microcontroller, Central Processing Unit—(CPU) with 32 kB of RAM and 128 kB of ROM to control all signal processing, input/output, and display functions for the analyzer. System power is supplied from a universal power supply module designed to be compatible with any international power source. (See *Major Internal Components* in chapter 5 *Maintenance* for the location of the power supply and the main electronic PC boards.)

The Temperature Control board is mounted under the electrical connection board. The signal processing electronics including the microprocessor, analog to digital, and digital to analog converters are located on the Motherboard at the front door of the unit. The Preamplifier board is

mounted on top of the Motherboard as shown in the figure 5.4. These boards are accessible after removing the back panel. Figure 2-2 is a block diagram of the Analyzer electronics.

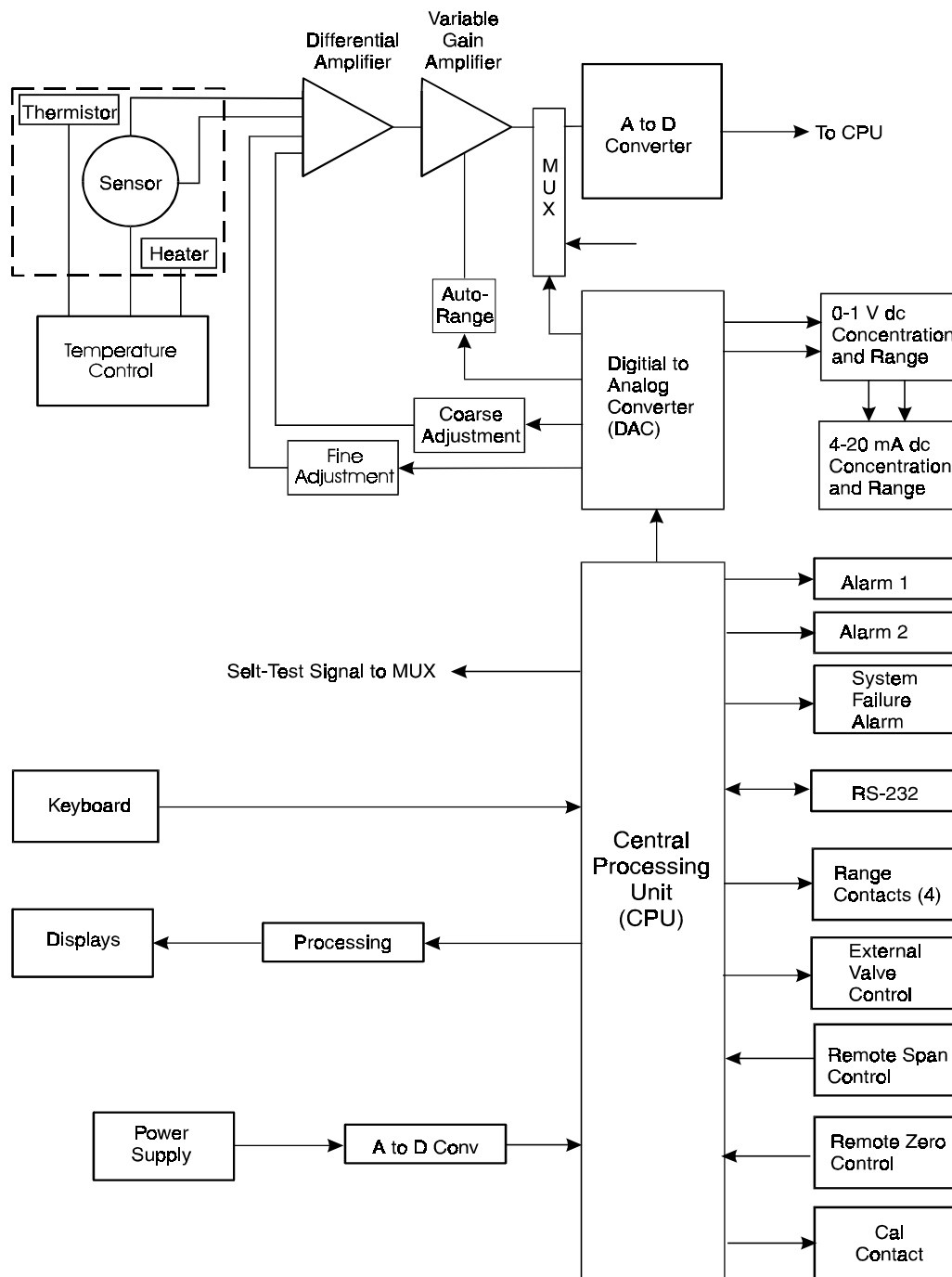

Figure 2-2: Block Diagram of the Model 2020 Electronics

The Temperature Control keeps the temperature of the measuring cell regulated to within 0.1 degree C. A thermistor is used to measure the temperature, and a zero-crossing switch regulates the power in a cartridge-type heater. The result is a sensor output signal that is temperature independent.

In the presence of dissimilar gases the sensor generates a differential voltage across its output terminals. A differential amplifier converts this signal to a unipolar signal, which is amplified in the second stage, variable gain amplifier, which provides automatic range switching under control of the CPU. The output from the variable gain amplifier is sent to an 18 bit analog to digital converter.

The digital concentration signal along with input from the Gas Selector Panel is processed by the CPU and passed on to the 12-bit DAC, which outputs 0-1 V dc Concentration and Range ID signals. An voltage-to-current converter provides 4-20 mA dc concentration signal and range ID outputs.

The CPU also provides appropriate control signals to the Displays, Alarms, and External Valve Controls, and accepts digital inputs for external Remote Zero and Remote Span commands. It monitors the power supply through an analog to digital converter as part of the data for the system failure alarm.

The RS-232 port provides two-way serial digital communications to and from the CPU. These, and all of the above electrical interface signals are described in detail in chapter 3 *Installation*.

2.4. Temperature Control

For accurate analysis the sensor of this instrument is temperature controlled to 60°C.

Installation

Installation of the Model 2020 Analyzer includes:

1. Unpacking
2. Mounting
3. Gas connections
4. Electrical connections
5. Testing the system.

3.1 Unpacking the Analyzer

The analyzer is shipped ready to install and prepare for operation. Carefully unpack the analyzer and inspect it for damage. Immediately report any damage to the shipping agent.

The four gas fittings that mate with the 1/4 NPT gas ports on the Model 2020, are not included. They must be supplied by the customer.

3.2 Mounting the Analyzer

The Model 2020 is designed for bulkhead mounting in hazardous environments. There are four mounting lugs—one in each corner of the enclosure, as shown in Figure 3-1. The outline drawing, at the back of this manual, gives the mounting hole size and spacing. The drawing also contains the overall dimensions. Do not forget to allow an extra 1³/₈" for the hinges.

Be sure to allow enough space in front of the enclosure to swing the door open—a 16 1/4" radius, as shown in Figure 3-2.

All electrical connections are made via cables which enter the explosion-proof housing through ports in its side. No conduit fittings are supplied. The installer must provide two 3/4" NPT and two 1" NPT adapters and the appropriate sealing conduit.

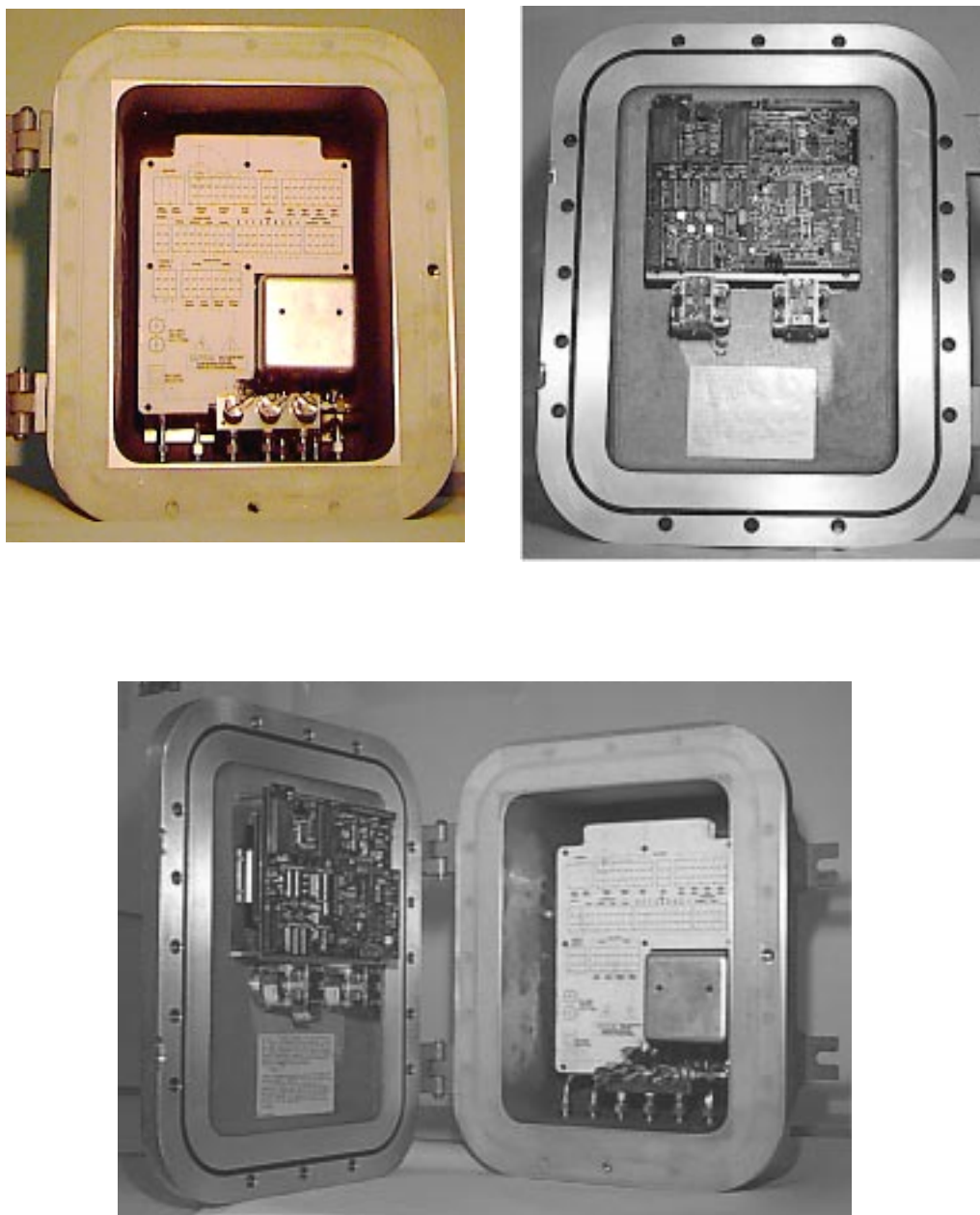

Figure 3-1a: Internal Views of the Model 2020

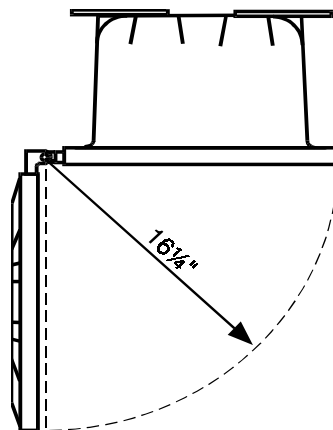

Figure 3-2: Required Front Door Clearance

3.3 Electrical Connections

Figure 3-3 shows the Model 2020 Electrical Connector Panel. There are terminal blocks for connecting power, communications, and both digital and analog concentration outputs.

For safe connections, ensure that no uninsulated wire extends outside of the connectors they are attached to. Stripped wire ends must insert completely into terminal blocks. No uninsulated wiring should be able to come in contact with fingers, tools or clothing during normal operation.

3.3.1 Primary Input Power

The power cord receptacle and fuse block are located in the same assembly. Insert the female plug end of the power cord into the power cord receptacle.

DANGER: *POWER IS APPLIED TO THE INSTRUMENT'S CIRCUITRY AS LONG AS THE INSTRUMENT IS CONNECTED TO THE POWER SOURCE. THE STANDBY FUNCTION IS FOR SWITCHING POWER ON / OFF TO THE DISPLAY AND OUTPUTS ONLY.*



The standard power supply requires a 115 V ac, 50-60 Hz power source. If you have the -N option, you will require 220 V ac, 50-60 Hz power.

3.3.2 Fuse Installation

The fuse block, at the right of the power cord receptacle, accepts US or European size fuses. A jumper replaces the fuse in whichever fuse receptacle is not used. Be sure to install the proper fuse as part of installation. (See *Fuse Replacement* in chapter 5, *maintenance*.)

3.3.3 Voltage Selections

There is a switch on the interface board, inside the instrument, that selects the working voltage between 230/115 VAC.



Voltage Selector Switch



Make sure the switch is in the proper position before powering the instrument.

3.3.4 Analog Outputs

There are four DC output signal connectors on the panel. There are two wires per output with the polarity noted. See Figure 3-4. The outputs are:

- 0–1 V dc % of Range: Voltage rises linearly with increasing concentration, from 0 V at 0 concentration to 1 V at full scale. (Full scale = 100% of programmable range.)
- 0–1 V dc Range ID: 0.25 V = Range 1, 0.5 V = Range 2, 0.75 V = Range 3, 1 V = Cal Range.
- 4–20 mA dc % Range: Current rises linearly with concentration, from 4 mA at 0 concentration to 20 mA at full scale. (Full scale = 100% of programmable range.)
- 4–20 mA dc Range ID: 8 mA = Range 1, 12 mA = Range 2, 16 mA = Range 3, 20 mA = Range 4.

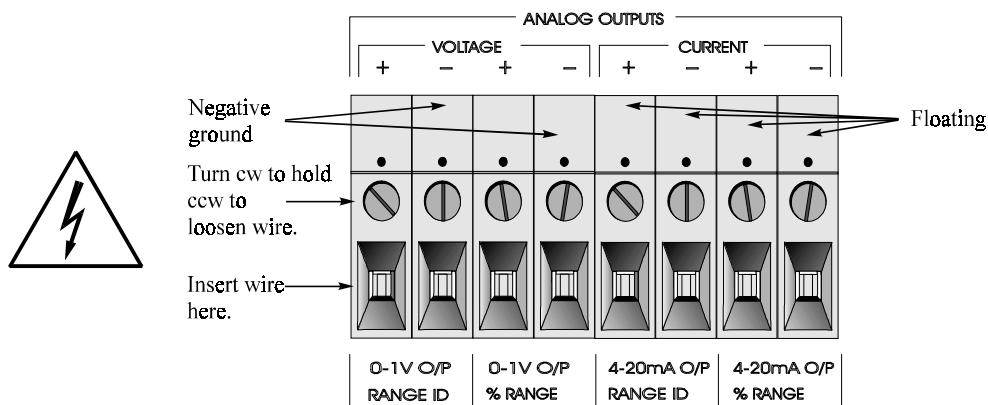

Figure 3-4: Analog Output Connections

Examples:

The analog output signal has a voltage which depends on gas concentration **relative** to the full scale of the range. To relate the signal output to the actual concentration, it is necessary to know what range the instrument is currently on, especially when the analyzer is in the autoranging mode.

The signal output for concentration is linear over the currently selected analysis range. For example, if the analyzer is set on a range that was defined as 0–10 % hydrogen, then the output would be as shown in Table 3-1.

Table 3-1: Analog Concentration Output—Example

| Percent Hydrogen | Voltage Signal Output (V dc) | Current Signal Output (mA dc) |
|------------------|------------------------------|-------------------------------|
| 0 | 0.0 | 4.0 |
| 1 | 0.1 | 5.6 |
| 2 | 0.2 | 7.2 |
| 3 | 0.3 | 8.8 |
| 4 | 0.4 | 10.4 |
| 5 | 0.5 | 12.0 |
| 6 | 0.6 | 13.6 |
| 7 | 0.7 | 15.2 |
| 8 | 0.8 | 16.8 |
| 9 | 0.9 | 18.4 |
| 10 | 1.0 | 20.0 |

To provide an indication of the range, the Range ID analog output terminals are used. They generate a steady preset voltage (or current when using the current outputs) to represent a particular range. Table 3-2 gives the range ID output for each analysis range.

Table 3-2: Analog Range ID Output—Example

| Range | Voltage (V) | Current (mA) | Application |
|---------------|-------------|--------------|---|
| Range 1 | 0.25 | 8 | 0-1 % H ₂ in N ₂ |
| Range 2 | 0.50 | 12 | 0-10 % H ₂ in N ₂ |
| Range 3 | 0.75 | 16 | 0-1 % H ₂ in Air |
| Range 4 (Cal) | 1.00 | 20 | 0-1 % H ₂ in N ₂ |

3.3.5 Alarm Relays

The three alarm-circuit connectors are spring terminals for making connections to internal alarm relay contacts. Each provides a set of Form C contacts for each type of alarm. Each has both normally open and normally closed contact connections. The contact connections are indicated by diagrams on the rear panel. They are capable of switching up to 3 amperes at 250 V ac into a resistive load. See Figure 3-5. The connectors are:

- Threshold Alarm 1:
- Can be configured as high (actuates when concentration is above threshold), or low (actuates when concentration is below threshold).
 - Can be configured as fail-safe or non-fail-safe.
 - Can be configured as latching or nonlatching.
 - Can be configured out (defeated).
- Threshold Alarm 2:
- Can be configured as high (actuates when concentration is above threshold), or low (actuates when concentration is below threshold).
 - Can be configured as fail-safe or non-fail-safe.
 - Can be configured as latching or nonlatching.
 - Can be configured out (defeated).
- System Alarm:
- Actuates when DC power supplied to circuits is unacceptable in one or more parameters. Permanently configured as fail-safe and latching. Cannot be defeated.
- Actuates when cell can not balance during zero calibration.
- Actuates when span parameter out off its limited parameter.

Actuates when self test fails.

To reset a system alarm, call out the set up menu by scroll keys. Use UP/DOWN key to select STANDBY function. Turn off analyzer by pressing ENTER key. Turn analyzer back on by selecting any key. Set ESC key twice.

Further detail can be found in chapter 4, section 4-5.



DANGEROUS VOLTAGES MAY STILL BE PRESENT AT THIS TERMINALS EVEN IF POWER TO THE INSTRUMENT IS REMOVED.

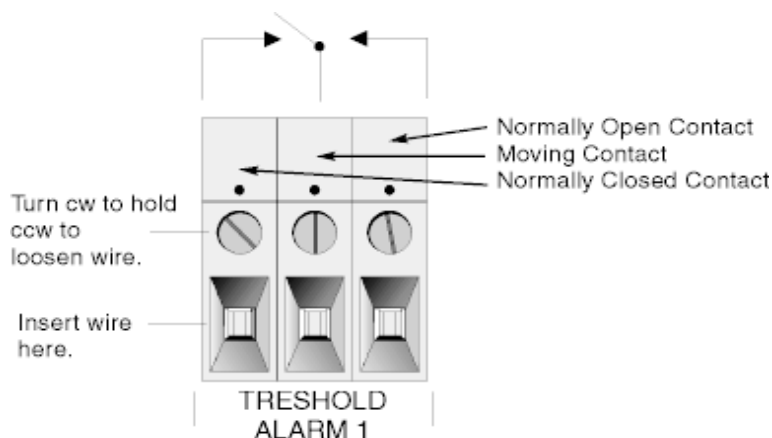

Figure 3-5: Types of Relay Contacts

3.3.6 Digital Remote Cal Inputs

Accept 0 V (off) or 24 V dc (on) inputs for remote control of calibration. (See *Remote Calibration Protocol* below.)

- Zero:** Floating input. 5 to 24 V input across the + and – terminals puts the analyzer into the *Zero* mode. Either side may be grounded at the source of the signal. A synchronous signal must open and close the external gas control valves appropriately. See 3.3.9 *Remote Probe Connector*. (With the –C option, the internal valves operate automatically.)
- Span:** Floating input. 5 to 24 V input across the + and – terminals puts the analyzer into the *Span* mode. Either side may be grounded at the source of the signal. A synchronous signal must open and close the external gas control valves appro-

riately. See 3.3.9 *Remote Probe Connector*. (With the –C option, the internal valves operate automatically.)

Cal Contact: This relay contact is closed while analyzer is spanning and/or zeroing. (See *Remote Calibration Protocol* below.)

Remote Calibration Protocol: To properly time the Digital Remote Cal Inputs to the Model 2020 Analyzer, the customer's controller must monitor the Cal Relay Contact.

When the contact is OPEN, the analyzer is analyzing, the Remote Cal Inputs are being polled, and a zero or span command can be sent.

When the contact is CLOSED, the analyzer is already calibrating. It will ignore your request to calibrate, and it will not remember that request.

Once a zero or span command is sent, and acknowledged (contact closes), release it. If the command is continued until after the zero or span is complete, the calibration will repeat and the Cal Relay Contact (CRC) will close again.

When the contact is closed, the display would display the last reading of the gas concentration value and output signal would output the last reading from the sample gas (SAMPLE and HOLD).

For example:

- 1) Test the CRC. When the CRC is open, Send a zero command until the CRC closes (The CRC will close quickly.)
- 2) When the CRC closes, remove the zero command.
- 3) When CRC opens again, send a span command until the CRC closes. (The CRC will close quickly.)
- 4) When the CRC closes, remove the span command.

When CRC opens again, zero and span are done, and the sample is being analyzed.

Note: The Remote Probe connector (paragraph 3.3.9) provides signals to operate the zero and span gas valves synchronously. However, if you have the –C Internal valve option, which includes zero and span gas inputs, the 2020 automatically regulates the zero, span and sample gas flow.

3.3.7 Range ID Relays

Four dedicated Range ID relay contacts. For any single application they are assigned to relays in ascending order. For example: if all ranges have the same application, then the lowest range is assigned to the Range 1

ID relay, and the highest range is assigned to the Range 3 ID relay. Range 4 is the Cal Range ID relay.

3.3.8 Network I/O

A serial digital input/output for local network protocol. At this printing, this port is not yet functional. It is to be used in future versions of the instrument.

3.3.9 RS-232 Port

The digital signal output is a standard RS-232 serial communications port used to connect the analyzer to a computer, terminal, or other digital device. Pin outs are listed in Table 3-3.

Table 3-3: RS-232 Signals

| RS-232 Sig | RS-232 Pin | Purpose |
|------------|------------|---------------------|
| DCD | 1 | Data Carrier Detect |
| RD | 2 | Received Data |
| TD | 3 | Transmitted Data |
| DTR | 4 | Data Terminal Ready |
| COM | 5 | Common |
| DSR | 6 | Data Set Ready |
| RTS | 7 | Request to Send |
| CTS | 8 | Clear to Send |
| RI | 9 | Ring Indicator |

Output: The data output is status information, in digital form, updated every two seconds. Status is reported in the following order:

- The concentration in ppm or percent
- Type of gas
- The range in use (01 = Range 1, 02 = Range 2, 03 = Range 3, CAL = Range 4)
- The scale of the range (0-100 %, etc)
- Which alarms—if any—are disabled (AL-x OFF)
- Which alarms—if any—are tripped (AL-x ON).

Each status output is followed by a carriage return and line feed.

Input: The input functions using RS-232 that have been implemented to date are described in Table 3-3.

Table 3-4: Commands via RS-232 Input

| Command | Description |
|--------------------|--|
| as <enter> | Immediately starts an autospan. |
| az <enter> | Immediately starts an autozero. |
| rp <enter> | Allows reprogramming of the APPLICATION (gas use) and ALGORITHM (linearization) <i>System</i> functions. |
| st <enter> | Toggling input. Stops/Starts any status message output from the RS-232, until st <enter> is sent again. |
| rm1 <enter> | Range manual 1 |
| rm2 <enter> | Range manual 2 |
| rm3 <enter> | Range manual 3 |
| rm4 <enter> | Range manual CAL |
| ra <enter> | Range auto |

Implementation: The RS-232 protocol allows some flexibility in its implementation. Table 3-4 lists certain RS-232 values that are required by the Model 2020 implementation.

Table 3-5: Required RS-232 Options

| Parameter | Setting |
|------------------|-----------|
| Baud | 2400 |
| Byte | 8 bits |
| Parity | none |
| Stop Bits | 1 |
| Message Interval | 2 seconds |

3.3.10 Remote Probe Connector

The 2020 is a single-chassis instrument, which has no Remote Probe Unit. Instead, the Remote Probe connector is used as another method for controlling external sample/zero/span gas valves. See Figure 3-6.

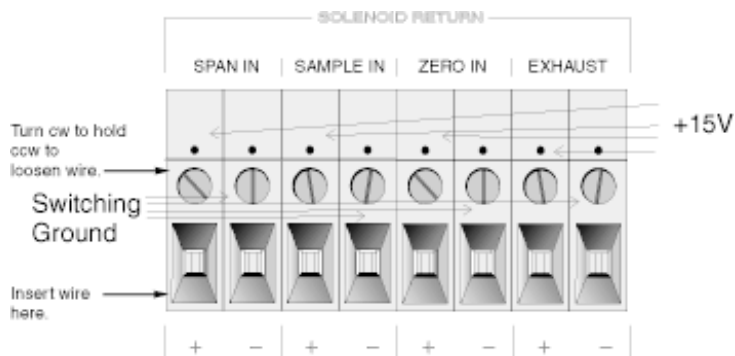

Figure 3-6: Remote Probe Connector Pinouts

The voltage from these outputs is nominally 0 V for the OFF and 15 V dc for the ON conditions. The maximum combined current that can be pulled from these output lines is 100 mA. (If two lines are ON at the same time, each must be limited to 50 mA, etc.) If more current and/or a different voltage is required, use a relay, power amplifier, or other matching circuitry to provide the actual driving current.

In addition, each individual line has a series FET with a nominal ON resistance of 5 ohms (9 ohms worst case). This could limit the obtainable voltage, depending on the load impedance applied. See Figure 3-7.

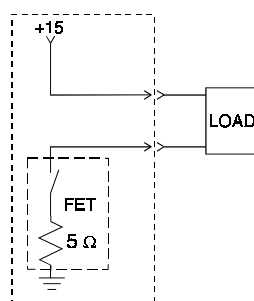

Figure 3-7: FET Series Resistance

3.4 Gas Connections

The gas fittings are accessed through holes on the underside of the analyzer chassis, as shown in Figure 3-8. Use $\frac{1}{8}$ NPT threaded conversion fittings to convert pipe to tube for these connectors.

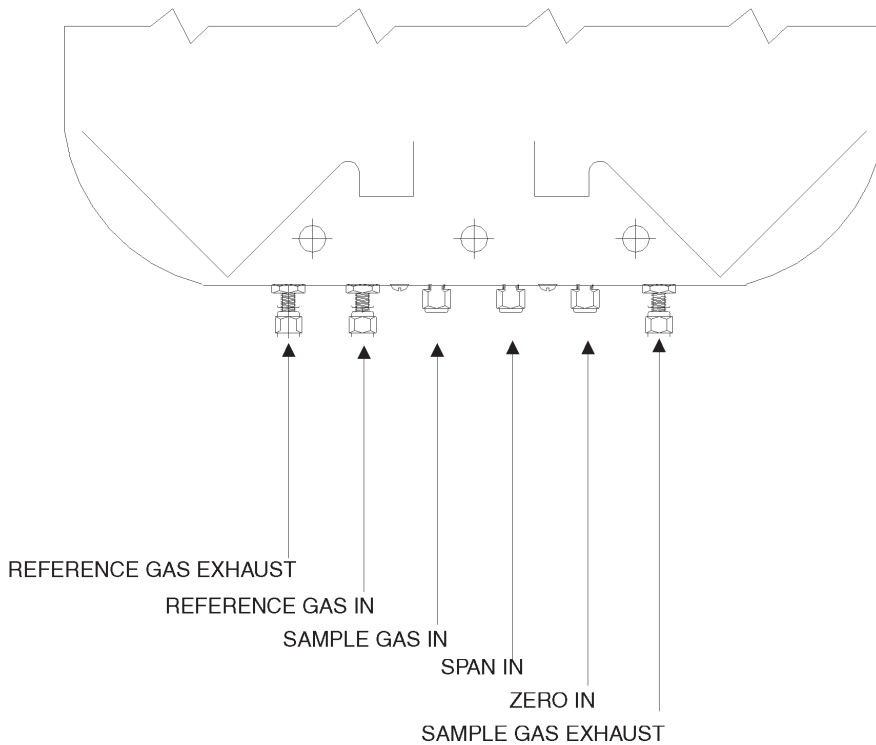

Figure 3-8: Gas Connections to the Basic Unit

There are no gas control valves inside the main chassis. A sample system must be provided for introduction of zero and span gas, as well as sample gas, into the sample path, and for controlling the flowrates through the sample and reference paths of the analyzer.

If you have purchased a gas selector panel from Analytical Instruments, the drawings at the back of this manual will contain a dimension drawing, with the modified cutout and hole pattern for mounting, and a drawing and/or addendum showing the gas connections. Figure 3-9 is an example showing a manual-valve panel with three valves (for sample, span and zero gases) and two flowmeters (one for reference and one for sample, span and zero gases).

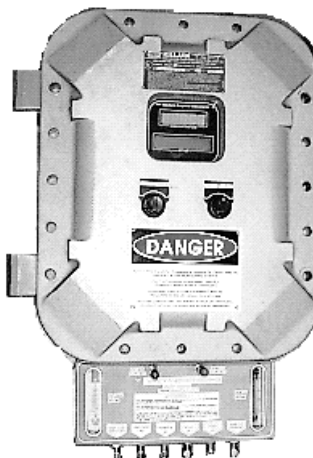

Figure 3-9: Front Panel with optional selector panel (as shown)

3.4.1 Sample System Design

Gas Connector and Selector Panels for specific applications are available at additional cost. These panels are optional designed to substitute a standard front panel.

For those customers wishing to incorporate their own sample system, electronic input/output ports are provided on the electrical connection board for the operation of solenoid valves under the complete control of the Model 2020 electronics. See section 3.3. The recommended system piping schematic is included among the drawings at the rear of the manual.

The unit is manufactured with $\frac{1}{4}$ inch tubing and $\frac{1}{8}$ NPT thread ports. The customer must provide matching fittings.

For best results, use the recommended piping system. Select a flowmeter that can resolve 0.08 scfh (40-50 cc/min) for the reference path of the analyzer, and select a flowmeter that can resolve 0.3 scfh (150 cc/min) for the sample path of the analyzer.

Note: The sample-line pressure regulator should be installed as close to the sample point as possible to minimize sample-line lag time.

NOTE: An additional option is available for SEALED reference application. This option would not have the reference Gas Flow Meter, Piping and Fittings.

3.4.2 Pressure and Flowrate Regulation

Appropriate pressure reducing regulators must be installed at all gas supply sources. To minimize flowrate adjustments the pressure regulators on the supporting gas supply cylinders should be adjusted to provide the same output pressure as the sample line regulator.

The gas pressure in should be reasonably well regulated. Pressures between 5 and 50 psig are acceptable (10 psig is normal) as long as the pressure, once established, will **keep the flow constant** during analysis and within an acceptable range (between 0.1 and 0.4 scfh—See Note).

Note: Gases lighter than air have a flowrate higher than indicated on the flowmeter, while gases heavier than air have a flowrate lower than indicated. Values can range from one half to twice the indicated flowrate.

For example: For hydrogen or helium, set the flowrate to 0.1 scfh (50 cc/min). For carbon dioxide or argon, set the flowrate to 0.4 scfh (200 cc/min).

When installing pressure regulators on supply cylinders, crack the cylinder valves so that gas is flowing during installation. This will eliminate the most common cause of standardization-gas contamination: air trapped during assembly diffusing back into the cylinder. This procedure is particularly important in applications where impurity content of 1 to 2 % is the range of interest.

Note: If you have the -V option, The above pressure and flow values apply instead to the vacuum at the VENT connector, described below, with minus signs before the pressure readings.

3.4.3 VENT Exhaust

There are two separate VENT fittings—one for the sample gas and one for the reference gas. Use 1/4 inch tubing for both sample and reference vents to minimize back pressure from restricted flow.

Exhaust connections must be consistent with the hazard level of the constituent gases. Check local, state, and federal laws, and ensure that the exhaust stream vents to an appropriately controlled area if required. If not vented to the same area, both VENT lines must vent to areas with equal

ambient pressures, and pressures must vary no more than the normal barometric changes.

Install VENT lines such that water and dirt cannot accumulate in them.

Note: If your 2020 has the –V option, see Note at end of *Pressure and Flow Rate Regulation*, above, for gas vacuum/flow considerations.

3.4.4 SAMPLE Gas

In the standard model, sample and calibration gases are introduced through the SAMPLE fitting. The gases must be Tee'd into the Sample inlet with appropriate valves.

The gas pressure in should be well regulated. (See section 3.4.1.) The sample line pressure regulator should be installed as close to the sample line as possible to minimize sample line lag time.

If greater flow is required for improved response time, install a bypass in the sampling system upstream of the analyzer input.

3.4.5 REFERENCE Gas

A gas of fixed composition is needed as a reference to which the sample gas will be compared. The reference gas is normally selected to represent the main background gas of the analysis.

For most applications, a constant supply of reference gas flowing at the same rate as the sample is required for best results. However, in many cases the flow of reference gas can be slowed to about 0.08 scfh (40 cc/min) with good results.

For some applications, an optional sealed air reference is installed. In sealed-reference sensors the reference side of the detector cell is filled with air and sealed. This eliminates the need to have reference gas constantly passing through the cell.

NOTE: For instruments equipped with the optional sealed air reference, there is no REFERENCE inlet or reference VENT port.

It is highly recommended that the same cylinder of gas be used for both the REFERENCE gas and the ZERO gas.

Pressure, flow, and safety considerations are the same as prescribed for the SAMPLE gas, above.

3.4.6 ZERO Gas

For the ZERO gas, a supply of the background gas, usually containing none of the impurity, is required to zero the analyzer during calibration. For suppressed zero ranges the zero gas must contain the low-end concentration of the impurity.

NOTE: Because most cylinder gases are between 99.95 and 99.98% pure, it is highly recommended that the same cylinder of gas be used for both REFERENCE and ZERO gas.

NOTE: It is essential to the accuracy of the analyzer that the purity of the zero gas be known. Otherwise, when the zero control is adjusted during zero standardization, the reading will indicate the impurity content of the zero gas, rather than zero.

3.4.7 SPAN Gas

For the SPAN gas, a supply of the background gas containing 70-100 % of the component of interest is required as a minimum.

Note: If your analyzer range is set for inverting output, your zero gas will be at 100% of the range interest, and span will be 70 to 100% of the low end range.

If linearization is required, intermediate concentrations of the target gas in the background gas may be necessary. From one to nine separate span gases may be used, depending on the desired precision of the linearization. See chapter 4, *Operation*.

3.5 Testing the System

Before plugging the instrument into the power source:

- Check the integrity and accuracy of the gas connections. Make sure there are no leaks.
- Check the integrity and accuracy of the electrical connections. Make sure there are no exposed conductors
- Check that the pressure and flow of all gases are within the recommended levels, and appropriate for your application.

Power up the system, and test it by performing the following operations:

1. Repeat the Self-Diagnostic Test as described in chapter 4, section 4.3.5.

Operation

4.1 Introduction

Although the Model 2020 is usually programmed to your application at the factory, it can be further configured at the operator level, or even, **cautiously**, reprogrammed. Depending on the specifics of the application, this might include all or a subset of the following procedures:

- Setting system parameters:
 - Establish a security password, if desired, requiring Operator to log in.
 - Establish and start an automatic calibration cycle, if desired.
- Routine Operation:
 - Calibrate the instrument.
 - Choose autoranging or select a fixed range of analysis.
 - Set alarm setpoints, and modes of alarm operation (latching, fail-safe, etc).
- Program/Reprogram the analyzer:
 - Define new applications.
 - Linearize your ranges.
- Special functions setup:
 - Set output reversal.
 - Set polarity reversal or offset output.S
 - Set gain amplification.

Before you configure your 2020, the following default values are in effect: RANGE/APPLICATIONS: refer to data sheet on the first page of this manual;

Range: Manual

Alarm Relays: Defeated, 0.00%, HI, *NOT* Fail/Safe, not latching

Zero: Auto, every 0 days 0 hours

Span: Auto, at 10%, every 0 days, at 0 hours

Password: TAI

4.2 Using the Controls

To get the proper response from these controls, turn the control toward the desired action (ESCAPE or ENTER—DOWN or UP), and then release it. Turn-and-release once for each action. For example, turn-and-release twice toward UP to move the VFD screen two selections upwards on the list of options (menu).

The item that is between arrows on the screen is the item that is currently selectable by choosing ENTER (turn-and-release toward ENTER with the ESCAPE/ENTER control).

In these instructions, to ENTER means to turn-and-release toward ENTER, and To ESCAPE means to turn-and-release towards ESCAPE. To scroll UP (or scroll DOWN) means to turn-and-release toward UP (or DOWN) as many times as necessary to reach the required menu item.

4.2.1 Mode/Function Selection

When the analyzer is first powered up, and has completed its initialization and self diagnostics, ESCAPE toggles the instrument between the ANALYZE screen (*Analysis Mode*) and the MAIN MENU screen (*Setup Mode*). The ANALYZE screen is the only screen of the *Analysis Mode*.

The MAIN MENU screen is the top level in a series of screens used in the *Setup Mode* to configure the analyzer for the specific application. The DOWN/UP commands scroll through the options displayed on the VFD screen. The selectable option appears between arrows. When you reach the desired option by scrolling, ENTER the selection as described below.

ESCAPE takes you back up the hierarchy of screens until you reach the ANALYZE MODE. ESCAPING any further just toggles between the MAIN MENU and the ANALYZE screen.

4.2.1.1 Analysis Mode

This is the normal operating mode. The analyzer monitors the concentration of the mixture content of the sample, displays the percent of the concentration in the sample stream, and warns of any alarm conditions.

SETUP MODE

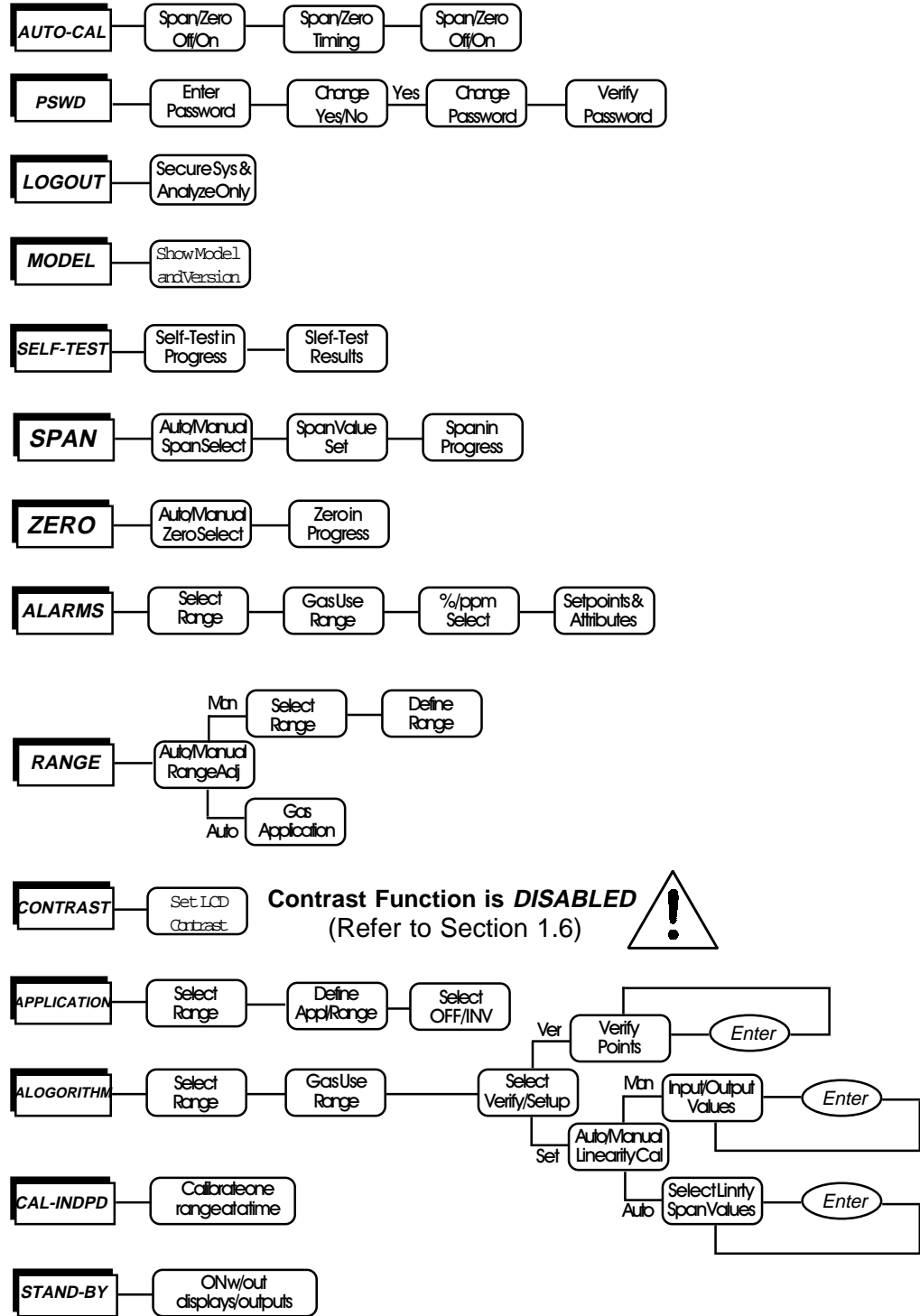

Figure 4-1: Hierarchy of Functions and Subfunctions

Either control switches you to *Setup Mode*. *Setup Mode* switches back to *Analyze Mode* if no controls are used for more than five seconds.

4.2.1.2 Setup Mode

The MAIN MENU consists of 14 functions you can use to customize and check the operation of the analyzer. Figure 4-1 shows the functions available with the 2020. They are listed here with brief descriptions:

- 1 **AUTO-CAL:** Used to define and/or start an automatic calibration sequence.
- 2 **PSWD:** Used to establish password protection or change the existing password.
- 3 **LOGOUT:** Logging out prevents unauthorized tampering with the analyzer settings.
- 4 **MODEL:** Displays Manufacturer, Model, and Software version of the instrument.
- 5 **SELF-TEST:** The instrument performs a self-diagnostic routine to check the integrity of the power supply, output boards, cell and amplifiers.
- 6 **SPAN:** Set up and/or start a span calibration.
- 7 **ZERO:** start a zero calibration.
- 8 **ALARMS:** Used to set the alarm setpoints and determine whether each alarm will be active or defeated, HI or LO acting, latching or not, and failsafe or not.
- 9 **RANGE:** Used to set up three analysis ranges that can be switched automatically with auto-ranging or used as individual fixed ranges.
- 10 **CONTRAST:** Increase or decrease the LCD screen contrast. **YOU MAY NEED TO DO THIS AT TURN-ON.** See *Setting the Display Contrast*, below.
- 11 **APPLICATIONS:** Restricted function, not generally accessed by the end user. Used to define up to three analysis ranges and a calibration range (including impurity, background low end of range, high end of range, and % of ppm units).
- 12 **ALGORITHM:** A restricted function, not generally accessed by the end user. Used to linearize the output for the range of interest.

- 13 CAL-INDEPD: Not generally accessed by the end user. Forces analyzer to be in independent calibration mode.
- 14 STANDBY: Remove power to outputs and displays, but maintain power to internal circuitry.

Any function can be selected at any time. Just scroll through the MAIN MENU with the DOWN/UP control to the appropriate function, and ENTER it. The analyzer will immediately start that function, unless password restrictions have been assigned. (Password assignment is explained further on.)

All of these functions are described in greater detail in the procedures starting in section 4.3. The VFD screen texts used to illustrate the procedures are reproduced in a *Monospaced* type style.

4.2.2 Data Entry

4.2.2.1 ENTER

When the selected option is a function on the Main Menu screen, the function name appears between the arrows on the screen. You activate the function by turning the ESCAPE/ENTER control to ENTER.

When the selected option is a **function or subfunction**, ENTER moves the display to the VFD screen for that function or subfunction.

When the selected option is a **modifiable item**, the DOWN/UP control can be used to increment or decrement that modifiable item to the value or action you want. Then you ENTER the item, which also puts you into the next field to continue programming.

When the last field is entered, ENTER takes you to the next screen in the process, or if the process is completed, ENTER takes you back to the ANALYZE screen.

4.2.2.2 ESCAPE

A turn-and-release toward ESCAPE moves the blinking to the next field on the left. When you are on the leftmost field, another ESCAPE takes you back to the previous screen.

If you do not wish to continue a function, you can abort the session by escaping to the leftmost field, and then issuing another ESCAPE. Escaping

a function takes the analyzer back to the previous screen, or to the ANALYZE Function, depending on the function escaped.

reproduced, at the appropriate point in the procedure, in a *Mono-spaced* type style. Push-button names are printed in *Oblique* type.

4.3.1 Setting the Display

Contrast Function is **DISABLED**
(Refer to Section 1.6)



If you cannot read anything on the display after first powering up:

1. Observe LED readout.
 - a. If LED meter reads all **eights and dots**, go to step 3.
 - b. If LED meter displays anything else, go to step 2.
2. Disconnect power to the Analyzer and reconnect again. LED meter should now read all eights and dots.

4.3.2 Setting up an AUTO-CAL

When proper automatic valving is connected (see chapter 3, *installation*), the Analyzer can cycle itself through a sequence of steps that automatically zero and span the instrument.

Note: Before setting up an AUTO-CAL, be sure you understand the *Zero* and *Span* functions as described in section 4.4, and follow the precautions given there.

Note: If you require highly accurate AUTO-CAL timing, use external AUTO-CAL control where possible. The internal clock in the Model 2020 is accurate to 2-3 %. Accordingly, internally scheduled calibrations can vary 2-3 % per day.

Note: If your ranges are configured for different applications, then AUTO-CAL will calibrate all of the ranges simultaneously (by calibrating the Cal Range).

To setup an AUTO-CAL cycle:

The VFD will display five subfunctions.

Call out MAIN MENU, scroll to AUTO-CAL function, and ENTER. A new screen for ZERO/SPAN set appears.

```
ZERO in  0d 0h off
SPAN in  0d 0h off
```

Use UP/DOWN Control to blink *ZERO* (or *SPAN*), then *Enter*. (You won't be able to set *OFF* to *ON* if a zero interval is entered.) A *Span Every ...* (or *Zero Every ...*) screen appears.

```
Zero schedule: OFF
Day:  0d Hour:  0h
```

Use UP/DOWN Control to set a value in days, then ENTER to move to the start-time value in hours. Use **UP/DOWN** to set a start-time value, then ENTER.

To turn **ON** the **SPAN** and/or **ZERO** cycles (to activate **AUTO-CAL**): use UP/DOWN Control to set the *OFF/ON* field to *ON*. You can now turn these fields *ON* because there is a nonzero span time defined.

4.3.3 Password Protection

Before a unique password is assigned, the system assigns **TAI** by default. This password will be displayed automatically. The operator just presses the Enter key to be allowed total access to the instrument's features.

If a password is assigned, then setting the following system parameters can be done only after the password is entered: **alarm** setpoints, **AUTO-CAL** setup. **ZERO/SPAN** calibration assigning a new **password, range/application** selections, and **curve algorithm** linearization. (**APPLICATION** and **ALGORITHM** are covered in the programming section.) However, the instrument can still be used for analysis or for initiating a self-test without entering the password. To defeat security the password must be changed back to **TAI**.

NOTE: If you use password security, it is advisable to keep a copy of the password in a separate, safe location.

4.3.3.1 Entering the Password

To install a new password or change a previously installed password, you must key in and *ENTER* the old password first. If the default password is in effect, pressing the *ENTER* button will enter the default **TAI** password for you.

Call out MAIN MENU setup by selecting any controls

Use the UP/DOWN key to scroll the blinking over to *PSWD*, and press *Enter* to select the password function. Either the default **TAI** password or **AAA** place holders for an existing password will appear on screen depending on whether or not a password has been previously installed.

```
Enter password:
  T A I
```

or

```
Enter password:
  A A A
```

The screen prompts you to enter the current password. If you are not using password protection, press *Enter* to accept TAI as the default password. If a password has been previously installed, enter the password using the ENTER key to scroll through the letters, and the **UP/DOWN** key to change the letters to the proper password. The last ENTER enters the password.

In a few seconds, you will be given the opportunity to change this password or keep it and go on.

```
Change Password?
<ENT>=Yes   <ESC>=No
```

Press *Escape* to move on, or proceed as in *Changing the Password*, below.

4.3.3.2 Installing or Changing the Password

If you want to install a password, or change an existing password, proceed as above in *Entering the Password*. When you are given the opportunity to change the password:

```
Change Password?
<ENT>=Yes   <ESC>=No
```

Enter to change the password (either the default **TAI** or the previously assigned password), or press *Escape* to keep the existing password and move on.

If you chose *Enter* to change the password, the password assignment screen appears.

```
Select new password
  T A I
```

or

Select new password

AAA

Enter the password using the UP/DOWN and ENTER to scroll through the existing password letters, and the UP/DOWN keys to change the letters to the new password. The full set of 94 characters available for password use are shown in the table below.

Characters Available for Password Definition:

| | | | | | | | | | |
|---|---|---|---|---|----|---|---|---|---|
| A | B | C | D | E | F | G | H | I | J |
| K | L | M | N | O | P | Q | R | S | T |
| U | V | W | X | Y | Z | [| ¥ |] | ^ |
| _ | ` | a | b | c | d | e | f | g | h |
| i | j | k | l | m | n | o | p | q | r |
| s | t | u | v | w | x | y | z | { | |
| } | → | ! | " | # | \$ | % | & | ' | (|
|) | * | + | , | - | . | / | 0 | 1 | 2 |
| 3 | 4 | 5 | 6 | 7 | 8 | 9 | : | ; | < |
| = | > | ? | @ | | | | | | |

When you have finished typing the new password, press *Enter*. A verification screen appears. The screen will prompt you to retype your password for verification.

Enter PWD To Verify:

A A A

Use the UP/DOWN key to retype your password and use ENTER to scroll through the letters, and last enter will complete verification. Your password will be stored in the microprocessor and the system will immediately switch to the *Analyze* screen, and you now have access to all instrument functions.

If all alarms are defeated, the *Analyze* screen appears as:

```
1.95    % H2 in N2
nR1:    Ø - 1Ø Anlz
```

If an alarm is tripped, the second line will change to show which alarm it is:

```
1.95    % H2 in N2
AL-1
```

NOTE: If you log off the system using the LOGOUT function in the MAIN MENU, you will now be required to reenter the password to gain access to Alarm, and Range functions.

4.3.4 Logging Out

The LOGOUT function provides a convenient means of leaving the analyzer in a password protected mode without having to shut the instrument off. By entering LOGOUT, you effectively log off the instrument leaving the system protected against use until the password is reentered. To log out, scroll to field of LOGOUT function, and ENTER to logout The screen will display the message:

```
Protected until  
password entered
```

4.3.5 System Self-Diagnostic Test

The Model 2020 has a built-in self-diagnostic testing routine. Preprogramming signals are sent through the power supply, output board, preamp board and sensor circuit. The return signal is analyzed, and at the end of the test the status of each function is displayed on the screen, either as OK or as a number between 1 and 1024. (See *System Self Diagnostic Test* in chapter 5 for number code.) If any of the functions fails, the System Alarm is tripped.

Note: The sensor will always show failed unless identical gas is present in both channels at the time of the SELF-TEST.

The self diagnostics are run automatically by the analyzer whenever the instrument is turned on, but the test can also be run by the operator at will. To initiate a self diagnostic test during operation, use the UP/DOWN key to scroll through the MAIN MENU to the SELF-TEST and *Enter*. The screen will follow the running of the diagnostic.

```
RUNNING DIAGNOSTIC  
Testing Preamp - Cell
```

When the testing is complete, the results are displayed.

```
Power: OK   Analog: OK  
Cell:    2   Preamp: 3
```

The module is functioning properly if it is followed by OK. A number indicates a problem in a specific area of the instrument. Refer to Chapter 5 *Maintenance and Troubleshooting* for number-code information. The results screen alternates for a time with:

```
Press Any Key  
To Continue...
```

Then the analyzer returns to the initial System screen.

4.3.6 The Model Screen

Scroll through the MAIN MENU to MODEL and Enter. The screen displays the manufacturer, model, and software version information.

4.3.7 Checking Linearity with ALGORITHM

Use UP/DOWN control to select **ALGORITHM**, and *Enter*.

```
sel rng to set algo:
-> 01 02 03 <-
```

Use the UP/DOWN Control to select the range: 01, 02, or 03. Then press *Enter*.

```
Gas Use:  H2 - N2
Range:    0  - 10%
```

Enter again.

```
Algorithm setup:
  VERIFY  SET UP
```

Use UP/DOWN key to select and *Enter* **VERIFY** to check whether the linearization has been accomplished satisfactorily.

```
Dpt  INPUT      OUTPUT
  0   0.00      0.00
```

The leftmost digit (under **Dpt**) is the number of the data point being monitored. Use the UP/DOWN key to select the successive points.

The **INPUT** value is the input to the linearizer. It is the simulated output of the analyzer. **You do not need to actually flow gas.**

The **OUTPUT** value is the output of the linearizer. It should be the **ACTUAL** concentration of the span gas being simulated.

If the **OUTPUT** value shown is not correct, the linearization must be corrected. *ESCAPE* to return to the previous screen. Select and Enter **SET UP** to Calibration Mode screen.

```
Select algorithm
mode :  AUTO
```

There are two ways to linearize: **AUTO** and **MANUAL**: The auto mode requires as many calibration gases as there will be correction points along

the curve. The user decides on the number of points, based on the precision required.

The manual mode only requires entering the values for each correction point into the microprocessor via the front panel buttons. Again, the number of points required is determined by the user.

4.4 The *Zero* and *Span* Functions

(1) The Model 2020 can have as many as three analysis ranges plus a special calibration range (Cal Range); and the analysis ranges, if more than one, may be programmed for separate or identical gas applications.

(2) If all ranges are for the same application, then you will not need the Cal Range. Calibrating any one of the ranges will automatically calibrate the others.

(3) If: a) each range is programmed for a different gas application, b) your sensor calibration has drifted less than 10 %, and c) your Cal Range was calibrated along with your other ranges when last calibrated, then you can use the Cal Range to calibrate all applications ranges at once.

If your Model 2020 analyzer fits the paragraph (3) description, above, use the Cal Range. If your analyzer has drifted more than 10 %, calibrate each range individually.

CAUTION: *Always allow 4-5 hours warm-up time before calibrating, if your analyzer has been disconnected from its power source. This does not apply if the analyzer was plugged in but was in STANDBY.*



The analyzer is calibrated using reference, zero, and span gases. Gas requirements are covered in detail in chapter 3, section 3.4 *Gas Connections*. Check that calibration gases are connected to the analyzer according to the instructions in section 3.4, observing all the prescribed precautions.

Note: **Shut off the gas pressure before connecting it to the analyzer, and be sure to limit pressure to 40 psig or less when turning it back on.**

Readjust the gas pressure into the analyzer until the flowrate through the sensor settles between 50 to 200 cc/min (approximately 0.1 to 0.4 scfh).

Note: **Always keep the zero calibration gases flow as close as the flowrate of sample gas as possible**

4.4.1 Zero Cal

The ZERO function in the MAIN MENU is used to enter the zero calibration function. Zero calibration can be performed in either the automatic or manual mode.

CAUTION: *If you are zeroing the Cal Range by itself (multiple application analyzers only), use manual mode zeroing.*



If you want to calibrate ALL of the ranges at once (multiple application analyzers only), use auto mode zeroing in the Cal Range.

Make sure the zero gas is flowing to the instrument. If you get a **CELL CANNOT BE BALANCED** message while zeroing skip to section 4.4.1.3.

4.4.1.1 Auto Mode Zeroing

Observe the precautions in sections 4.4 and 4.4.1, above. Scroll to ZERO function by using UP/DOWN control and enter the zero function mode. The screen allows you to select whether the zero calibration is to be performed automatically or manually. Use the UP/DOWN key to toggle between **AUTO** and **MAN** zero settling. Stop when **AUTO** appears, blinking, on the display.

```
Select zero
mode: AUTO
```

Press *Enter* to begin zeroing.

```
#####.## % H2 - N2
Slope=#.### C-Zero
```

The beginning zero level is shown in the upper left corner of the display. As the zero reading settles, the screen displays and updates information on **Slope=** in ppm/second (unless the Slope starts within the acceptable zero range and does not need to settle further). The system first does a course zero, shown in the lower right corner of the screen as **C—Zero**, for approximate 3 min, and then does a fine zero, and displays **F—Zero**, for approximate 3 min.

Then, and whenever Slope is less than 0.01 for at least 3 min, instead of Slope you will see a countdown: **9 Left**, **8 Left**, and so fourth. These are software steps in the zeroing process that the system must complete, AF-

TER settling, before it can go back to *Analyze*. Software zero is indicated by **S-Zero** in the lower right corner.

```
#####.## % H2 - N2
4 Left=##### S-Zero
```

The zeroing process will automatically conclude when the output is within the acceptable range for a good zero. Then the analyzer automatically returns to the *Analyze* mode.

4.4.1.2 Manual Mode Zeroing

Scroll to *Zero* and enter the *Zero* function. The screen that appears allows you to select between automatic or manual zero calibration. Use the UP/DOWN keys to toggle between **AUTO** and **MAN** zero settling. Stop when **MANUAL** appears, blinking, on the display.

```
Select zero
mode: MANUAL
```

Enter to begin the zero calibration. After a few seconds the first of three zeroing screens appears. The number in the upper left hand corner is the first-stage zero offset. The microprocessor samples the output at a predetermined rate.

```
#####.## % H2 - N2
Zero adj:2048 C-Zero
```

The analyzer goes through C-Zero, F-Zero, and S-Zero. During C-Zero and F-Zero, use the UP/DOWN keys to adjust displayed **Zero adj**: value as close as possible to zero. Then, press *Enter*.

S-Zero starts. During S-Zero, the Microcontroller takes control as in *Auto Mode Zeroing*, above. It calculates the differences between successive samplings and displays the rate of change as **Slope**= a value in parts per million per second (ppm/s).

```
#####.## % H2 - N2
Slope=##### S-Zero
```

Generally, you have a good zero when **Slope** is less than 0.05 ppm/s for about 30 seconds.

Once zero settling completes, the information is stored in the analyzer's memory, and the instrument automatically returns to the *Analyze* mode.

4.4.1.3 Cell Failure

Cell failure in the 2020 is usually associated with inability to zero the instrument with a reasonable voltage differential across the Wheatstone bridge. If this should ever happen, the 2020 system alarm trips, and the VFD displays a failure message.

Cell cannot be balanced
Check your zero gas

Before replacing the sensor:

- a. Check your zero gas to make sure it is within specifications.
- b. Check for leaks downstream from the sensor, where contamination may be leaking into the system.
- c. Check flowmeter to ensure that the flow is no more than 200SCCM
- d. Check temperature controller board.
- e. Check gas temperature.

If none of the above as indicated, the sensor may need to be replaced. Check warranty, and contact Analytical Instruments Customer Service.

4.4.2 Span Cal

The *Span* button on the front panel is used to span calibrate the analyzer. Span calibration can be performed in either the automatic or manual mode.

CAUTION: *If you are spanning the Cal Range by itself (multiple application analyzers only), use manual mode zeroing.*



If you want to calibrate ALL of the ranges at once (multiple application analyzers only), use auto mode spanning in the Cal Range.

Make sure the span gas is flowing to the instrument.

4.4.2.1 Auto Mode Spanning

Observe all precautions in sections 4.4 and 4.4.2, above. Scroll SPAN and enter the span function. The screen that appears allows you to select whether the span calibration is to be performed automatically or manually.

Use the UP/DOWN key to toggle between **AUTO** and **MAN** span settling. Stop when **AUTO** appears, blinking, on the display.

```
Select span
mode: AUTO
```

Enter to move to the next screen.

```
Span Val: 20.00 %
<ENT> To begin span
```

Use UP/DOWN key to change the span setting value.

ENTER will move the blinking field to units (%/ppm). Use UP/DOWN key to select the units, as necessary. When you have set the concentration of the span gas you are using, *Enter* to begin the Span calibration.

```
#####.##% H2 - N2
Slope=##### Span
```

The beginning span value is shown in the upper left corner of the display. As the span reading settles, the screen displays and updates information on **Slope**. Spanning automatically ends when the span output corresponds, within tolerance, to the value of the span gas concentration. Then the instrument automatically returns to the analyze mode.

4.4.2.2 Manual Mode Spanning

Scroll Span by using UP/DOWN key and Enter to start the Span function. The screen that appears allows you to select whether the span calibration is to be performed automatically or manually.

```
Select span
mode: MANUAL
```

Use the UP/DOWN key to toggle between **AUTO** and **MAN** span setting. Stop when **MAN** appears, blinking, on the display. ENTER to move to next subfunction screen

```
Span Val: 20.00 %
<ENT> To begin span
```

Using the UP/DOWN key changes the span value, as necessary. *Enter* to move to the units field (%/ppm). Use UP/DOWN key to select unit.

Press *Enter* to enter the span value into the system and begin the span calibration.

Once the span has begun, the microprocessor samples the output at a predetermined rate. It calculates the difference between successive sam-

plings and displays this difference as Slope on the screen. It takes several seconds for the first Slope value to display. Slope indicates rate of change of the Span reading. It is a sensitive indicator of stability.

```

###.##%   H2 - N2
Slope=#.###   Span

```

When the *Span* value displayed on the screen is sufficiently stable, press *Enter*. (Generally, when the *Span* reading changes by 1 % or less of the range being calibrated for a period of ten minutes it is sufficiently stable.) Once *Enter* is pressed, the *Span* reading changes to the correct value. The instrument then **automatically** enters the *Analyze* function.

4.5 The Alarms Function

The Model 2020 is equipped with 6 fully adjustable set points concentration with two alarms and a system failure alarm relay. Each alarm relay has a set of form "C" contacts rated for 3 amperes resistive load at 250 V ac. See Figure in Chapter 3, *Installation* and/or the Interconnection Diagram included at the back of this manual for relay terminal connections.

The system failure alarm has a fixed configuration described in chapter 3 *Installation*.

The concentration alarms can be configured from the front panel as either *high* or *low* alarms by the operator. The alarm modes can be set as *latching* or *non-latching*, and either *fail-safe* or *non-fail-safe*, or, they can be *defeated* altogether. The setpoints for the alarms are also established using this function.

Decide how your alarms should be configured. The choice will depend upon your process. Consider the following four points:

1. Which if any of the alarms are to be high alarms and which if any are to be low alarms?

Setting an alarm as HIGH triggers the alarm when the contaminant concentration rises above the setpoint. Setting an alarm as LOW triggers the alarm when the contaminant concentration falls below the setpoint.

Decide whether you want the alarms to be set as:

- Both high (high and high-high) alarms, or
 - One high and one low alarm, or
 - Both low (low and low-low) alarms.
2. Are either or both of the alarms to be configured as failsafe?

In failsafe mode, the alarm relay de-energizes in an alarm condition. For non-failsafe operation, the relay is energized in an alarm condition. You can set either or both of the concentration alarms to operate in failsafe or non-failsafe mode.

3. Are either of the alarms to be latching?

In latching mode, once the alarm or alarms trigger, they will remain in the alarm mode even if process conditions revert back to non-alarm conditions. This mode requires an alarm to be recognized before it can be reset. In the non-latching mode, the alarm status will terminate when process conditions revert to non-alarm conditions.

4. Are either of the alarms to be defeated?

The defeat alarm mode is incorporated into the alarm circuit so that maintenance can be performed under conditions which would normally activate the alarms.

The defeat function can also be used to reset a latched alarm. (See procedures, below.)

If you are using password protection, you will need to enter your password to access the alarm functions. Follow the instructions in section 4.3.3 to enter your password. Once you have clearance to proceed, enter the *Alarm* function.

Note: If all ranges are for the same application, set any one of them will automatically set the others.

Press the *Alarm* button on the front panel to enter the *Alarm* function. Make sure that **01** is blinking.

```
Set rng to set alm:
-> 01 02 03    <-
```

Set up the Range 1 alarm by moving the blinking over to **01** using the UP/DOWN arrow keys. Then *Enter*. Check the gas application and range limits as displayed on the screen.

```
Gas use: H2 - N2
Range:   0 - 10 %
```

Press enter again to set the alarm setpoints.

```
Set %/ppm alm to set
AL1-PPM  AL2-PPM
```

Use the UP/DOWN keys to choose between % or ppm units. Then *Enter* to move to the next screen.

```
AL1: 1000 ppm HI
Dft:N Fs:N Ltch:N
```

Five parameters can be changed on this screen:

- Value of the alarm setpoint, AL1: #####
- Out-of-range direction, HI or LO
- Defeated? Dft:Y/N (Yes/No)
- Failsafe? Fs:Y/N (Yes/No)
- Latching? Ltch:Y/N (Yes/No).
- To define the setpoint, use the UP/DOWN **key while screen is** blinking over to AL1: #####. Use the UP/DOWN key to change the number. Holding down the key speeds up the incrementing or decrementing.
- After the number (value) has been chosen, use Enter to move the desired parameter. Then use the UP/DOWN keys to change the parameter.
- Once the parameters for alarm have been set, Enter the alarm function again, and repeat this procedure for next alarm.
- To reset a latched alarm, go to Dft– and then use either UP two times or DOWN two times. (Toggle it to Y and then back to N.)

–OR –

Go to Ltch– and then use either UP two times or DOWN two times. (Toggle it to N and back to Y.)

4.6 The Range Select Function

The *Range* function allows you to manually select the concentration range of analysis (MANUAL), or to select automatic range switching (AUTO).

In the MANUAL screen, you are further allowed to define the high and low (concentration) limits of each Range, and select a single, fixed range to run.

CAUTION: *If this is a linearized application, the new range must be within the limits previously programmed using the System function, if linearization is to apply throughout the range. Furthermore, if the limits are too small a part (approx 10 % or less) of the originally linearized range, the linearization will be compromised.*



In the **AUTO** screen, you are further allowed to select which gas application (PREVIOUSLY defined in *APPLICATION* function) to run.

4.6.1 Manual (Select/Define Range) Screen

The Manual range-switching mode allows you to select a single, fixed analysis range. It then allows you to redefine the upper and lower limits, for the range.

Use UP/DOWN key to start the RANGE function, and ENTER

```
Select range
mode: MANUAL
```



Note: If all three ranges are currently defined for different application gases, then the above screen does not display (because mode must be manual). Instead, the VFD goes directly to the following screen.

If above screen displays, use the UP/DOWN arrow keys to Select **MANUAL**, and press *Enter*.

```
Select range to run
-> 01 02 03 CAL<-
```

Use the UP/DOWN keys to select the range: 01, 02, 03, or CAL. Then press *Enter*.

```
Gas use:  H2 - N2
Range:    0 - 10 %
```

Use the ENTER key to move the range to low-end field. Use ENTER key to move the range to high-end field. Use the UP/DOWN keys to change the values of the fields.

Press *Escape* to return to the previous screen to select or define another range.

Press *Enter* to return the to the *Analyze* function.

4.6.2 Auto (Single Application) Screen

Autoranging will automatically set to the application that has at least two range setup with the same gases.

In the autoranging mode, the microprocessor automatically responds to concentration changes by switching ranges for optimum readout sensitivity. If the upper limit of the operating range is reached, the instrument

automatically shifts to the next higher range. If the concentration falls to below 85% of full scale of the next lower range, the instrument switches to the lower range. A corresponding shift in the DC concentration output, and in the range ID outputs, will be noticed.

The autoranging feature can be overridden so that analog output stays on a fixed range regardless of the contaminant concentration detected. If the concentration exceeds the upper limit of the range, the DC output will saturate at 1 V dc (20 mA at the current output).

However, the digital readout and the RS-232 output of the concentration are unaffected by the fixed range. They continue to read beyond the full-scale setting until amplifier saturation is reached. Below amplifier saturation, the over range readings are accurate UNLESS the application uses linearization over the selected range.

The concentration ranges can be redefined using the *Range* function Manual screen, and the application gases can be redefined using the APPLICATION function, if they are not already defined as necessary.



CAUTION: Redefining applications or ranges might require re-linearization and/or recalibration.

To setup automatic ranging:

Select range on the MAIN MENU, and ENTER to start the Range function.

```
Select range  
mode : AUTO
```

Note: If all three ranges are currently defined for different application gases, then the above screen does not display (because mode must be manual).

If above screen displays, use the UP/DOWN key to Select AUTO, and *Enter*.

Press *Escape* to return to the previous Analyze Function.

4.6.3 Precautions

The Model 2020 allows a great deal of flexibility in choosing ranges for automatic range switching. However, there are some pitfalls that are to be avoided.

Ranges that work well together are:

- Ranges that have the same lower limits but upper limits that differ by approximately an order of magnitude
- Ranges whose upper limits coincide with the lower limits of the next higher range
- Ranges where there is a gap between the upper limit of the range and the lower limit of the next higher range.

Range schemes that are to be avoided include:

- Ranges that overlap
- Ranges whose limits are entirely within the span of an adjoining range.

Figure 4-2 illustrates these schemes graphically.

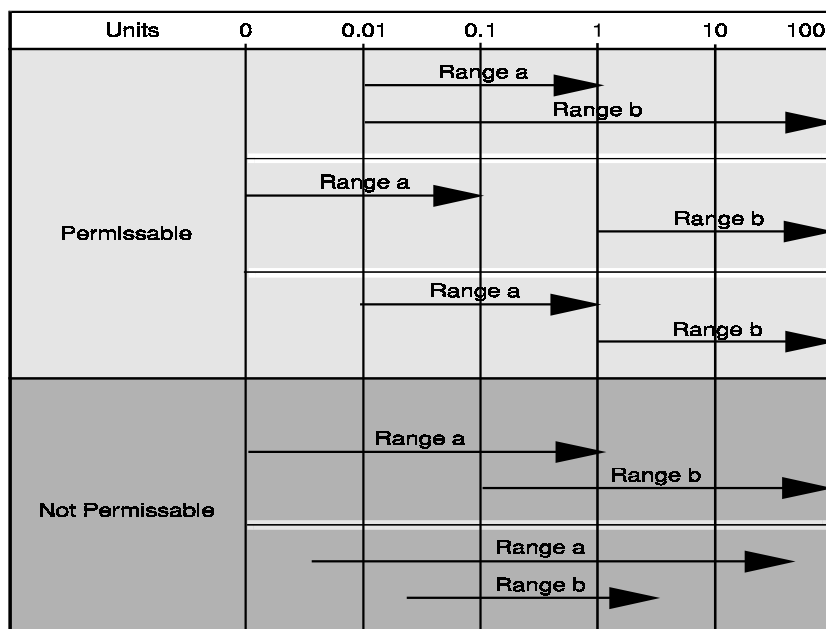

Figure 4-2: Examples of Autoranging Schemes

4.7 The Analyze Function

Normally, all of the functions automatically switch back to the *Analyze* function when they have completed their assigned operations. Pressing

the *Escape* button in many cases also switches the analyzer back to the *Analyze* function. Alternatively, if you leave your analyzer on MAIN MENU screen within 5 seconds without touching any key, it will automatically return to analyze function. If the analyzer is in subfunction mode, in most cases, it will automatically return to analyze mode within 10 minutes.

The *Analyze* function screen shows the impurity concentration and the application gases in the first line, and the range in the second line. In the lower right corner, the abbreviation **Anlz** indicates that the analyzer is in the *Analyze* mode. If there is an * before the **Anlz**, it indicates that the range is linearized.

```
1.95 % H2 - N2
nR1:0 -10 *Anlz
```

n indicates non inverting range

i indicates inverting range

If the concentration detected is over range, the first line of the display blinks continuously.

4.8 Programming

CAUTION: *The programming functions of the Set Range and Curve Algorithm screens are configured at the factory to the users application specification. These functions should only be reprogrammed by trained, qualified personnel.*



To program, you must:

1. Enter the password, if you are using the analyzer's password protection capability.
2. Connect a computer or computer terminal capable of sending an RS-232 signal to the analyzer RS-232 connector. (See chapter 3 *Installation* for details). Send the **rp** command to the analyzer.

Now you will be able to select the APPLICATION and ALGORITHM setup functions.

4.8.1 The Set Application Screen

The Set Application screen allows reprogramming of the three analysis ranges and the calibration range (including impurity gas, background gas, low end of range, high end of range, and % or ppm units). Original programming is usually done at the factory according to the customer's application. It must be done through the RS-232 port using a computer running a terminal emulation program.



Note: It is important to distinguish between this *System* programming subfunction and the *Range* button function, which is an operator control. The Set Range Screen of the *Application* function allows the user to DEFINE the upper and lower limits of a range AND the application of the range. The *Range* function only allows the user to select or define the limits, or to select the application, but not to define the application.

Normally the Model 2020 is factory set to default to manual range selection, unless it is ordered as a single-application multiple-range unit (in which case it defaults to autoranging). In either case, autoranging or manual range selection can be programmed by the user.

In the autoranging mode, the microprocessor automatically responds to concentration changes by switching ranges for optimum readout sensitivity. If the upper limit of the operating range is reached, the instrument automatically shifts to the next higher range. If the concentration falls to below 85% of full scale of the next lower range, the instrument switches to the lower range. A corresponding shift in the DC concentration output, and in the range ID outputs, will be noticed.

The autoranging feature can be overridden so that analog output stays on a fixed range regardless of the contaminant concentration detected. If the concentration exceeds the upper limit of the range, the DC output will saturate at 1 V dc (20 mA at the current output).

However, the digital readout and the RS-232 output of the concentration are unaffected by the fixed range. They continue to read beyond the full-scale setting until amplifier saturation is reached. Below amplifier saturation, the over range readings are accurate UNLESS the application uses linearization over the selected range.

To program the ranges, you must first perform the four steps indicated at the beginning of section 4.8 *Programming*. You will then be in the MAIN MENU and selecting application function screen.

```
Set rng to set appl:  
-> 01 02 03 CAL <-
```

Use the UP/DOWN key to increment/decrement the range number to 01, 02, 03, or CAL, and *Enter*.

```
Imp:  H2  Bck:  N2
FR:  0   TO: 10  %
```

Use the UP/DOWN key to increment the respective parameters as desired.

Use the ENTER to move from Imp: (impurity) to Bck: (background), FR: (from—lower end of range), TO: (to—upper end of range), and PPM or %.

Last *Enter* will accept the values and the screen will display

```
OFFST/INVRT:  <ENT>
Standard:     <ESC>
```

ESC if your application is standard. If your application requires OFFSET or Reversal output, ENTER will set your output as OFFSET or REVERSAL. (See special function setup section 4.9 for more information).

. (See note below.) Repeat for each range you want to set.

Note: The ranges must be increasing from low to high, for example, if Range 1 is set to 0–10 % and Range 2 is set to 0–100 %, then Range 3 cannot be set to 0–50 % since that makes Range 3 lower than Range 2.

Ranges, alarms, and spans are always set in either percent or ppm units, as selected by the operator, even though all concentration-data outputs change from ppm to percent when the concentration is above 9999 ppm.

Note: When performing analysis on a fixed range, if the concentration rises above the upper limit as established by the operator for that particular range, the output saturates at 1 V dc (or 20 mA). However, the digital readout and the RS-232 output continue to read regardless of the analog output range.

To end the session, send:

```
st<enter>
st<enter>
```

to the analyzer from the computer.

4.8.2 The Curve Algorithm Screen

The Curve Algorithm is a linearization method. It provides from 1 to 9 intermediate points between the ZERO and SPAN values, which can be normalized during calibration, to ensure a straight-line input/output transfer function through the analyzer. (*Before setting the alogorithm curve, each range must be Zeroed and Spanned*).

Each range is linearized individually, as necessary, since each range will usually have a totally different linearization requirement.

To linearize the ranges, you must first perform the four steps indicated at the beginning of section 4.8 *Programming*. You will then be in the MAIN MENU and select ALOGORITHM.

4.8.2.1 Checking the linearization

From the *MAIN MENU* screen, select **ALGORITHM**, and *Enter*.

```
Sel rng set algo
-> 01 02 03 <-
```

Use the UP/DOWN key to select the range: 01, 02, or 03. Then press *Enter*.

```
Gas use: H2 - N2
Range: 0 -10 %
Enter again.
```

```
Algorithm setup:
  VERIFY  SETUP
```

UP/DOWN to select and *Enter* **VERIFY** to check whether the linearization has been accomplished satisfactorily.

```
Dpt  INPUT    OUTPUT
  0   0.00    0.00
```

The leftmost digit (under **Dpt**) is the number of the data point being monitored. Use the UP/DOWN keys to select the successive points.

The **INPUT** value is the input to the linearizer. It is the simulated output of the analyzer. **You do not need to actually flow gas.**

The **OUTPUT** value is the output of the linearizer. It should be the **ACTUAL** concentration of the span gas being simulated.

If the **OUTPUT** value shown is not correct, the linearization must be corrected. *ESCAPE* to return to the previous screen. Select and Enter **SET UP** to Calibration Mode screen.

```
Select algorithm
mode : AUTO
```

There are two ways to linearize: **AUTO** and **MANUAL**: The auto mode requires as many calibration gases as there will be correction points along the curve. The user decides on the number of points, based on the precision required.

The manual mode only requires entering the values for each correction point into the microprocessor via the front panel buttons. Again, the number of points required is determined by the user.

Note: Before performing section 4.8.2 or 4.8.2.3, you must check to ensure that your calibration gases or points are between low end and high end of the range setup. All correction points must be between the Zero and the Span concentration. Do not enter the Zero and Span points as part of the correction

4.8.2.2 Manual Mode Linearization

To linearize manually, you must have previous knowledge of the nonlinear thermal-conductivity characteristics of your gases. You enter the value of the differential between the actual concentration and the apparent concentration (analyzer output). Analytical Instruments has tabular data of this type for a large number of gases, which it makes available to customers on request. See Appendix for ordering information. To enter data:

From the MAIN MENU Screen—

1. Use UP/DOWN to select **ALGORITHM**, and *Enter*.
2. Select and *Enter* **SETUP**.
3. **Select MANUAL** from the Calibration Mode Select screen.

| Dpt | INPUT | OUTPUT |
|-----|-------|--------|
| 0 | 0.00 | 0.00 |

The data entry screen resembles the verify screen, but the gas values can be modified and the data-point number cannot.

Use the UP/DOWN key to set the INPUT value for the lowest concentration into the first point. ENTER to move to OUTPUT field. Use the UP/DOWN key to set the OUTPUT value, the lowest concentration into the first point. ENTER to accept the first setting.

After each point is entered, the data-point number increments to the next point. Moving from the lowest to the highest concentration, use the UP/DOWN keys to set the proper values at each point.

| Dpt | INPUT | OUTPUT |
|-----|-------|--------|
| 0 | 0.00 | 0.00 |

Repeat the above procedure for each of the data points you are setting (up to nine points: 0-8). Set the points in unit increments. Do not skip numbers. The linearizer will automatically adjust for the number of points entered.

When you are done, *ESCAPE*. The message, **Completed. Wait for calculation**, appears briefly, and then the main *System* screen returns.

To end the session, send:

st<enter>

st<enter>

to the analyzer from the computer.

4.8.2.3 Auto Mode Linearization

To linearize in the Auto Mode, you must have on hand a separate calibration gas for each of the data points you are going use in your linearization. First, the analyzer is zeroed and spanned as usual. Then, each special calibration gas, for each of the intermediate calibration points, is flowed, in turn, through the sensor. As each gas flows, the differential value for that intermediate calibration point is entered from the front panel of the analyzer.

Note: The span gas use to span the analyzer must be >90% of the range being analyzed.

Before starting linearization, perform a standard calibration. See section 4.4. To enter data:

From the *MAIN MENU* screen—

1. Use UP/DOWN to select **ALGORITHM**, and *Enter*.
2. Select and *Enter* **SETUP**.
3. *Enter* **AUTO** from the Calibration Mode Select screen.

The Auto Linearize Mode data entry screen appears.

| | | | |
|----------|----|------|----|
| 1.95 % | H2 | - | N2 |
| Input(0) | : | 2.00 | |

5. Use the UP/DOWN keys to set the proper value of calibration gas, and *Enter*. Repeat this step for each cal-point number as it appears in the **Input (x)** parentheses.

6. Repeat step 5 for each of the special calibration gases, from the lowest to the highest concentrations. *Escape* when done.

To end the session, send:

st<enter>

st<enter>

to the analyzer from the computer.

4.9 Special Function Setup

CAUTION: *The programming functions of the output signal reversal, polarity reversal and gain preset are configured at the factory to the users application specification. These functions should only be reprogrammed by trained, qualified personnel.*



4.9.1 OFFSET OUTPUT/Reversal Output

4.9.1.1 Output Signal Reversal

Some applications require a reversal of the output signals in order for the 4-20mA and 0-1 V DC output signals to correspond with the low and high end of the concentration range. For example, if an application involves the analysis of 85-100% oxygen in a background of argon by measuring the thermal conductivity of the binary gas, the analyzer would normally be set up so that the 100% oxygen (0% argon) concentration would correspond to the zero level (4mA 0 V) of the output signal. Then, 85% oxygen (15% argon) would correspond to 20mA (1 V) in the signal output.

It may be convenient for the user to have the outputs reversed so that the 85-100% oxygen level outputs a 4-20mA (0-1 V) signal respectively. This can be accomplished by reversing the data input to the custom settings. Not all applications will require a reversing function, however, if this is desirable. This can be programmed by allowing the user to set the analyzer to read reversal output. Contact the factory for further information.

4.9.1.2 Output Signal Offset

TAI has provided the output offset feature in the software for the accuracy purpose. In many cases, the analyzer does not require this feature. For example, if the analyzer has setup to analyze the sample gas of 40-50%

argon in nitrogen, normally zero gas of this application requires 40% argon in nitrogen. However, 100% of nitrogen can be used to zero the analyzer. In this case, the output offset is not needed to setup. For linear output the accuracy will access successfully within +/-1% off. But, if the application is analyzing the sample gas that is not linearly, the accuracy of the analyzer may not meet the specification. Therefore, output offset require and yet 40% argon in nitrogen is also needed for zero calibration gas.

To set up the output reversal or output offset, see section 4.8.1-set APPLICATION scen.

NOTE: If the inverting has been setup, “i” shall display on the left bottom corner. Otherwise, the left bottom corner display ”n”.

4.9.2 Polarity Reversal

In some special applications, user will find that the display dispalys negative concentration values, even if proper span gas is injected. For example, if application involves the analysis of 0-10% nitrogen in argon, and the reference chamber is sealed with air instead of argon, the microprocesor will be detecting signal and process assuming that the reference chamber is flowing with argon. However, in this case, the seal air reference that is compared to background of argon from the measurement chamber which has higher coeffiction parameter and then will cause the analyzer to go negative. To correct this problem, TAI has added the Polarity Correction feature. This feature can be set as follow:

Close S1-5 range 1

Close S1-6 range 2

Close S1-7 range 3

Close S1-8 cal range

Select STANDBY to restart the system.

4.9.3 Gain Preset

NOTE: This function will apply only for the analyzer that has multiple range with single application and non-linearity.

For nonlinear application, signal that produces from the thermal conductivity, will not correspond to the actual gas concentration. The amplification of each range will not agree, therefore, the gain must be preset in order for the signal to read linearly. To set the gain, the following must be performed in sequence.

NOTE: Before setting up this feature, you must have a span gas containing 90%-100% of the lowest range of the analyzer.

1. Set unit range to lowest range.

NOTE: For output reversal, the lowest range should be range 3, else the lowest range is range 1.

2. Connect span gas to span inlet.
3. Use UP/DOWN key to scroll to the CAL-INDEPD function.
4. Hold Escape/Enter control to ENTER position for approximately 10 seconds until the upper right connect display “ok” message.
5. Use UP/DOWN scroll to select SPAN function, then setup the setting to span level. Press ENTER key to span.

NOTE: You must do step #5 before the analyzer return to analyze mode. If the analyzer returns to analyze function, you must repeat step 3-5 again.

6. Set range to next range
7. Repeat steps 3-5 until you reach the last range of the row.

Maintenance

5.1 Routine Maintenance



Aside from normal cleaning and checking for leaks at the gas connections, routine maintenance is limited to replacing fuses, and recalibration. For recalibration, see Section 4.4 *Calibration*.



WARNING: SEE WARNINGS ON THE TITLE PAGE OF THIS MANUAL.

5.2 System Self Diagnostic Test

Use UP/DOWN key to enter the SELF-TESTY function.

The following failure codes apply:

Table 5-1: Self Test Failure Codes

Power

| | |
|---|--------------|
| 0 | OK |
| 1 | 5 V Failure |
| 2 | 15 V Failure |
| 3 | Both Failed |

Analog

| | |
|---|-----------------------------|
| 0 | OK |
| 1 | DAC A (0–1 V Concentration) |
| 2 | DAC B (0–1 V Range ID) |
| 3 | Both Failed |

Preamp

| | |
|---|---------------|
| 0 | OK |
| 1 | Zero too high |

- 2 Amplifier output doesn't match test input
- 3 Both Failed
- >3 Open gain resistor

Cell

- 0 OK
- 1 Failed (open filament, short to ground, no power.)
- 2 Unbalance (deterioration of filaments, blocked tube)

5.3 Fuse Replacement

The 2020 requires two 5 x 20 mm, 4 A, T type (Slow Blow) fuses. The fuses are located inside the explosion proof housing on the Electrical Connector Panel, as shown in Figure 5-1. To replace a fuse:

1. Disconnect the Unit from its power source.
2. Place a small screwdriver in the notch in the fuse holder cap, push in, and rotate 1/4 turn. The cap will pop out a few millimeters. Pull out the fuse holder cap and fuse, as shown in Figure 5-1.

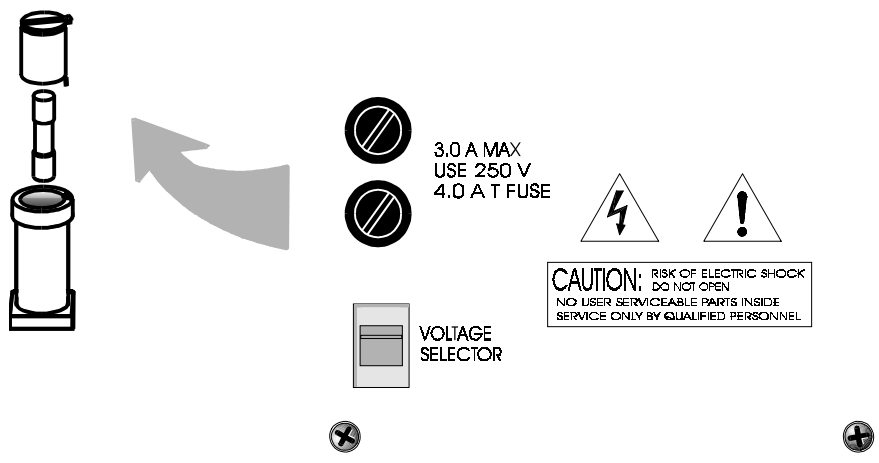

Figure 5-1: Removing Fuse Cap and Fuse from Holder

3. Replace fuse by reversing process in step 1.

Remove Power to the instrument before changing fuses.

5.4 Major Internal Components

The Cell Compartment and Front Panel PCBs are accessed by unlatching and swinging open the front panel, as described earlier. The balance of the PCBs are accessed by removing the rear panel retaining screws and sliding out the entire subassembly. See Figure 5-3, below. The major electronic components locations are shown in Figure 5-4 (with Cell Compartment removed for clarity).

WARNING: SEE WARNINGS ON THE TITLE PAGE OF THIS MANUAL.



The 2020 contains the following major components:

- Analysis Section
 - Cell Compartment
 - Cell Block
- Power Supply
- Preamp and Motherboard with Microcontroller
- Display Board and Displays
 - 5 digit LED meter
 - 2 line, 20 character, alphanumeric, VFD display
- Rear Panel Board.



5.5 Voltage Selections

There is a switch on the interface board, inside the instrument, that selects the working voltage between 230/115 VAC.

Voltage Selector Switch



Make sure the switch is in the proper position before powering the instrument.

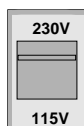

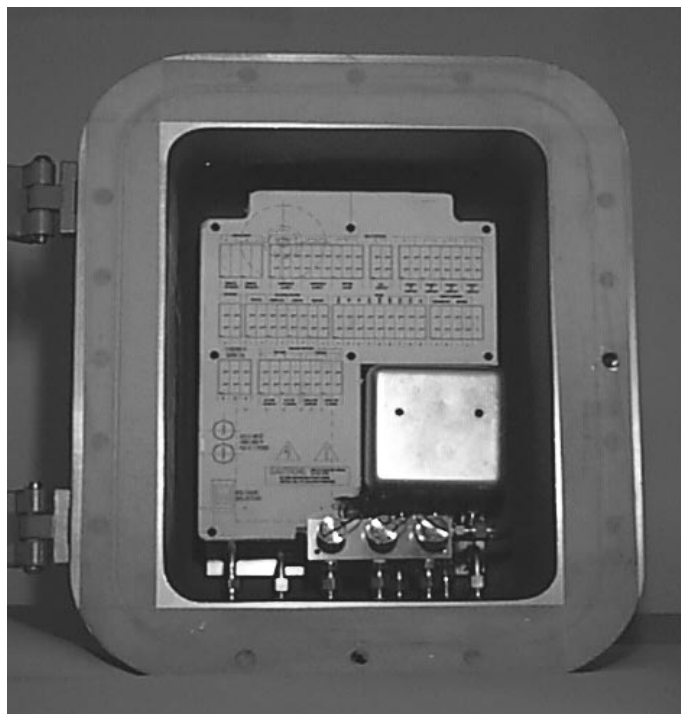

Figure 5-3: Rear Panel Retaining Screws

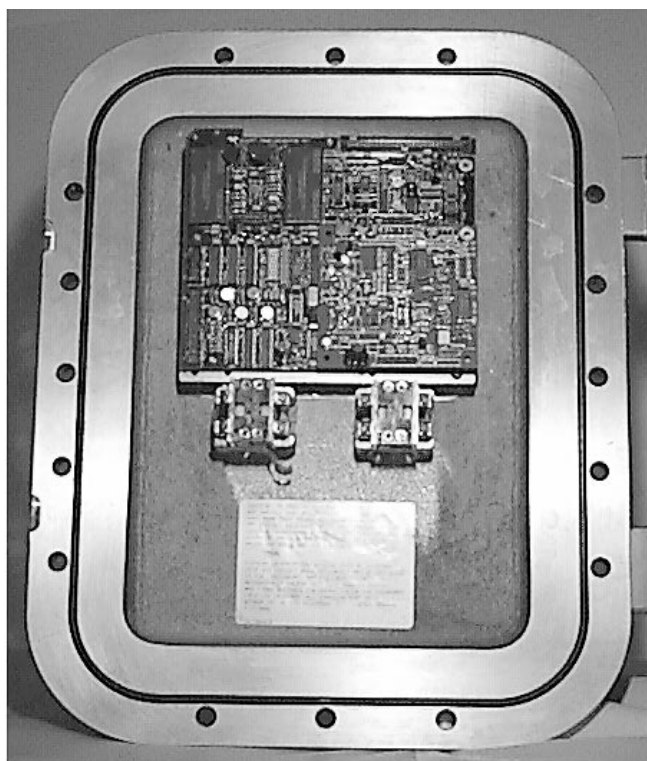

Figure 5-4: Locations of Printed Circuit Board Assemblies

See the drawings in the Drawings section in back of this manual for details.

5.6 Cell, Heater, and/or Thermistor Replacement

The Thermal Conductivity Cell, with its Heater and Thermistor, is mounted inside the insulated cell compartment, just behind the analyzer's front panel access door. To remove the one of these components, you must first slide the entire Cell Compartment out of the analyzer through the front panel access door as described in the procedure below. Figure 5-5 identifies the five screws that must be removed in order to remove the Cell Compartment.

5.6.1 Removing the Cell Compartment

WARNING: IF THE MODEL 2020 ANALYZER HAS BEEN USED WITH TOXIC GASES, FLUSH IT THOROUGHLY BEFORE PERFORMING THIS PROCEDURE.



WARNING: DISCONNECT ALL POWER TO THE MODEL 2020 BEFORE PERFORMING THIS PROCEDURE.

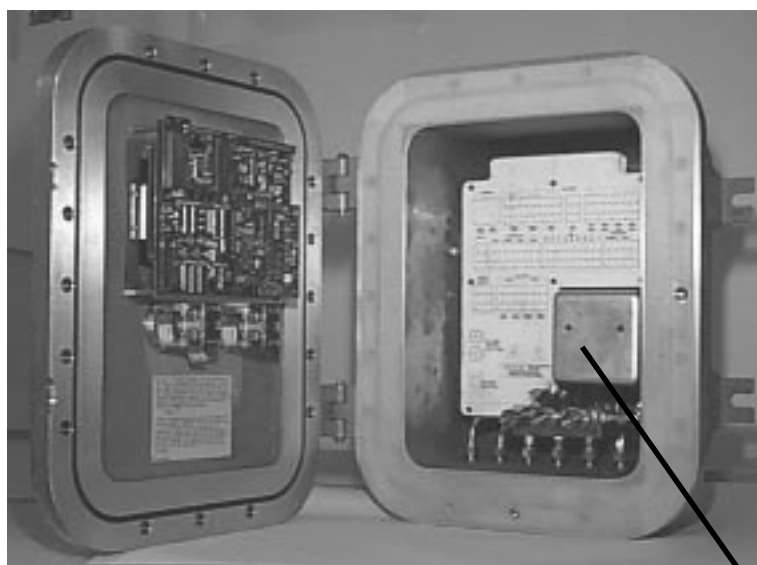

Figure 5-5: Location of Cell Compartment

To remove the Cell Compartment:

- a. Disconnect gas and electrical connections to the analyzer.
- b. Remove analyzer from its mounting, and remove gas fittings from the gas ports on the bottom of the analyzer, so that nothing projects from the ports.
- c. Remove the Cell Compartment retaining screws identified in Figure 5-5. You will have to unlatch and swing open the front panel door to remove the front screws.
- d. Carefully pull the Cell Compartment out through the front of the analyzer. There is enough length to the cell's electrical wiring to allow this.
- e. After replacing the necessary component and reassembling the Cell Compartment, Replace the Compartment by reversing the above procedure, steps a through d.

5.6.2 Removing and Replacing the Cell Block

- a. Refer to Figure 5-6, which illustrates removal of the Cell Block from the Cell Compartment. Exploded view is as seen from the top of the Cell Block.

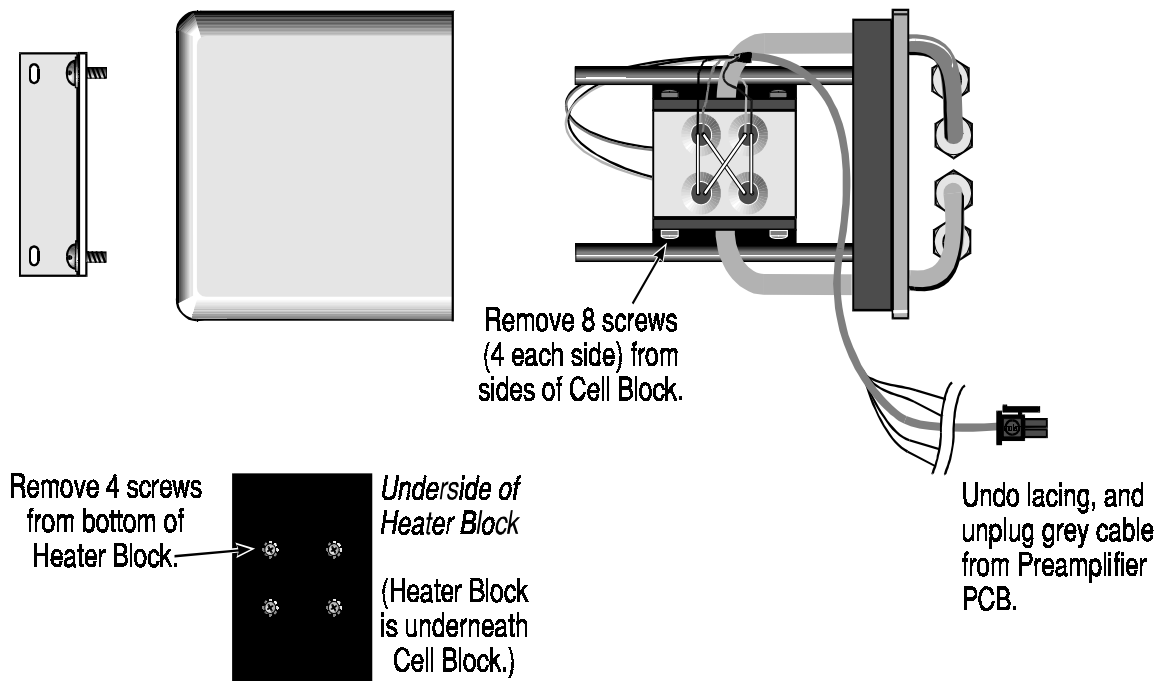

Figure 5-6: Removal of Cell from Cell Housing

- b. Remove the two screws holding the front mounting bracket—they also hold the Cell Block Cover to the Cell Block—and then pull off the cover.
- c. Turn the uncovered Cell Block assembly over so that the bottom faces you. The black rectangular block with four screws is the Heater Block. Separate the Heater Block from the Cell Block by removing the four screws. Leave the Heater Block electrical connections connected.
- d. Remove the four screws from each of the black plates that hold the Cell. The Cell is sandwiched between the plates. You should now be able to slide the Cell free.
- e. Leave the electrical connections connected at the Cell. Unlace the cabling, and unplug the grey Cell cable at the Preamplifier PCB connector, J3. (See Figure 5-4, and/or drawings at the rear of this manual.) The Preamplifier PCB can be more easily accessed by removing the analyzer's rear panel. (See Section 5.5.)
- f. Replace the cell by reversing the above procedure, steps a through e.

5.6.3 Removing the Heater and/or Thermocouple

- a. Refer to Figure 5-7, which illustrates removal of the Thermistor and/or Heater from the Cell Compartment. Exploded view is as seen from the bottom of the Cell Block.

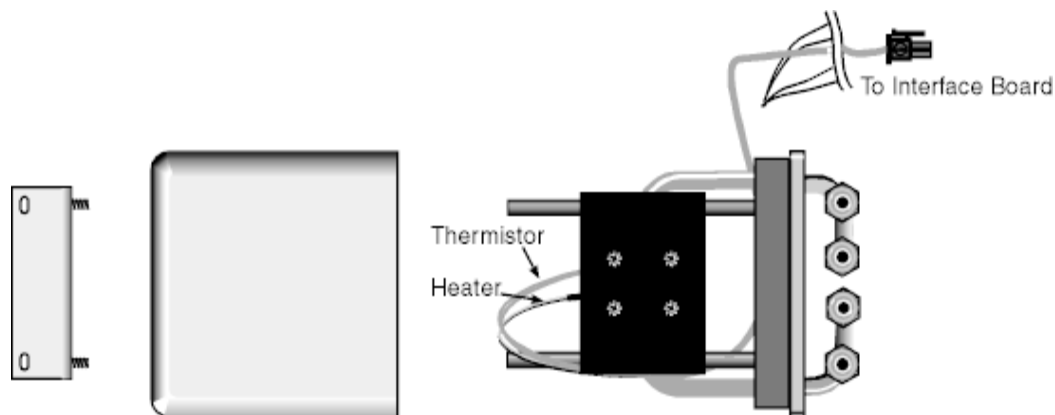

Figure 5-7: Removing the Heater and/or Thermocouple

- b. Remove the two screws holding the front mounting bracket—they also hold the Cell Block Cover to the Cell Block—and then pull off the cover.

-
- c. Turn the uncovered Cell Block assembly over so that the bottom faces you. The black rectangular block with four screws is the Heater Block.
 - d. The Heater is fastened to the Heater Block by a set screw as well as the silicone sealing compound. The Thermistor is fastened only by the silicone sealer.
 - (1) To remove the Heater, use a $1/16$ " Allen wrench to loosen the Thermistor set screw. Then, grasp BOTH Heater wires firmly, and pull the Heater slowly out of the Heater Block, breaking the silicone seal. Do not allow any foreign matter to enter the empty duct.
 - (2) To remove the Thermistor, grasp BOTH Thermistor wires firmly, and pull the Thermistor slowly out of the Heater Block, breaking the silicone seal. Do not allow any foreign matter to enter the empty duct.
 - e. Undo the cable lacing and separate the Heater/Thermistor wires. Then, disconnect the wires from TS1 on the Temperature Control Board. (See Figures 5-4 and 5-7.)

5.6.4 Replacing the Heater and/or Thermocouple

- a. To replace the Heater and/or Thermocouple, coat the new element with silicone sealing compound, and insert it into the duct.

CAUTION: *The larger duct is for the Heater element, and the smaller duct is for the Thermocouple.*



- b. Enough sealing compound should be on the element to spill over and seal around the wire where it enters the duct. Smooth the outer seal and remove any excess.
- c. Reassemble the Cell Compartment by reversing the procedure in section 5.6.3. Then replace the cabling.
- d. Reinstall the Assembled Cell Compartment by reversing the procedure in section 5.6.1. Then reconnect the wires to TS1 on the Temperature Control board.

5.7 Cleaning

If instrument is unmounted at time of cleaning, disconnect the instrument from the power source. Close and latch the front-panel access door. Clean outside surfaces with a soft cloth dampened slightly with plain clean water. Do not use any harsh solvents such as paint thinner or benzene.

For mounted instruments, DO NOT wipe the front panel while the instrument is controlling your process. Clean the front panel as prescribed in the above paragraph.

5.8 Phone Numbers

Customer Service: (818) 934-1673

Environmental Health and Safety: (818) 934-1592

Fax: (818) 961-2538

EMERGENCY ONLY: (24-hour pager) 1-800-759-7243
PIN # 1858192

Appendix

A-1 Specifications

Ranges: Three ranges plus a cal range with linearizer, field selectable within specified limits (application dependent) and Auto Ranging

Display: 2 line by 20 alphanumeric VFD accompanied by 5 digit LED display

Accuracy: $\pm 1\%$ of full scale for most binary mixtures at constant temperature
 $\pm 5\%$ of full scale over operating temperature range once temperature equilibrium has been reached

Response Time: 90% in less than 65 seconds

System Operating

Temperature: 32°F to 122°F (0 - 50°C)

Sensor Type: Standard TC cell filaments detector)

Signal Output: Two 0-1 VDC (concentration and range ID)
Two 4-20 mADC isolated (concentration and range ID)

Alarm: Two fully programmable concentration alarm set points and corresponding Form C, 3 amp contacts.

One system failure alarm contact to detect power, calibration, zero / span and sensor failure.

System Power

Requirements: 115/230 VAC, 50-60Hz

Cell Material: Nickel plated brass block with nickel alloy filaments and stainless steel and plates

O/P Interface: Full duplex RS-232, implement a subset of Tracs Command

Mounting: Explosion-Proof Housing, Bulkhead Mounting.

Options: (C) Electrically operated CAL/ZERO valves
(H) SS Sampling System (SS cell block gold filaments)
(R) Sealed Reference TC Cell
(L) Flow Control Gas Panel
(F) Flame Arrestors for group C & D service with Flow Control Gas Panel.
(O) Flame Arrestors for group B service with Control Gas Panel.
(P) Flame Arrestors for group C & D with CAL valves with Control Gas Panel.
(Q) Flame arrestors for group B with CAL valves with Control Gas Panel.

A-2 Recommended 2-Year Spare Parts List

| <i>Qty</i> | <i>Part Number</i> | <i>Description</i> |
|------------|--------------------|--|
| 1 | D67472 | Back Panel Board |
| 1 | C62371B | Front Panel Board |
| 1 | C65098A | Preamplifier Board |
| 1 | C62365D | Main Computer Board |
| 2 | F1295 | Fuse, 4 A, 250 V, 5 × 20 mm, T—Slow Blow |

* Order one type only: US or European, as appropriate.

Note: Orders for replacement parts should include the part number (if available) and the model and serial number of the instrument for which the parts are intended.

Orders should be sent to:

TELEDYNE Analytical Instruments

16830 Chestnut Street
City of Industry, CA 91749-1580

Phone 626) 934-1500, Fax (818) 961-2538
TWX (910) 584-1887 TDYANYL COID

Web: www.teledyne-ai.com

or your local representative.

A-3 Drawing List

| | |
|---------|--|
| D67110 | Outline Drawing (Basic and Standard Options) |
| D-67113 | Interconnection and Piping Diagram |

